

# **NEW** Operator Accessories



## Series 2000 Garage Door Price List

01.09.2015



# Hörmann Garage Doors



## HÖRMANN IS ALWAYS COMMITTED TO EXCELLENCE: “In Engineering, in User Safety and in Design.”

All our products are third party tested to the highest standards and are certified to the high safety requirements and performance characteristics of the European Standard 13241-1.

This gives you the reassurance that your purchase of a Hörmann product is a safe investment. We are also committed to our national network of Garage Door Specialist Distributors.

These are independent businesses, who believe in customer service and have skills to advise you on the best product for your property, also providing quality fitting and finishing.

**“A great product performs at its best when fitted by experts.”**

### Door Operating Systems

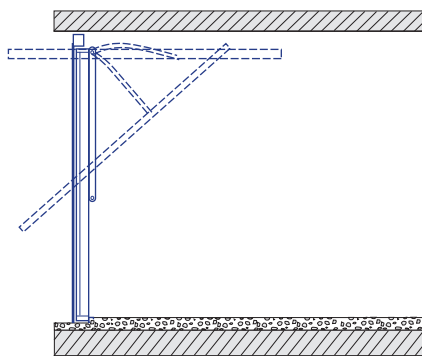

Canopy Operating Gear

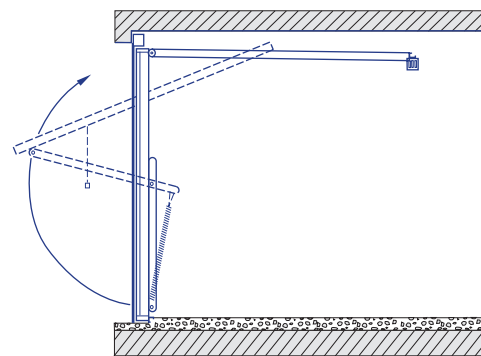

Retractable Operating Gear

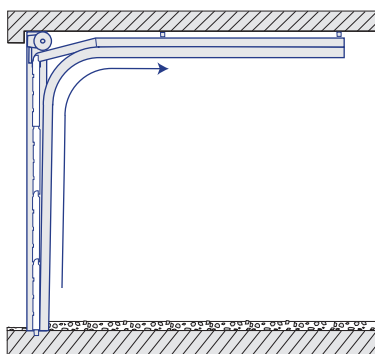

Sectional Operating Gear

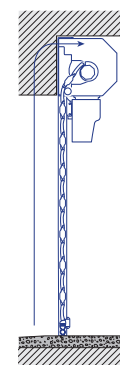

RollMatic Operating Gear

We reserve the right to change specification without prior notification.

# Contents



## Up-and-over garage doors

Canopy and retractable with steel infill	4
Canopy and retractable with timber infill	8
Canopy and retractable with GRP infill (Glass reinforced polyester)	12



## Sectional garage doors

Sectional Garage Doors LTE 40 Single-skinned steel Sectional doors	14
Sectional Garage Doors LPU 40 Double-skinned steel Sectional doors	15
Optional extras and window designs	18



## Sectional double-leaf side doors

Sectional double-leaf side doors with block frames made of aluminium profiles	19
---	----





## RollMatic roller garage doors

RollMatic Roller Garage Doors	20
-------------------------------	----

Garage door operators	23
-----------------------	----

Operator accessories	23
----------------------	----

 FIT 1 BS 1-button radio internal push button	27
--	----

 FIT 4 BS 4-button radio internal push button	27
--	----

 FIT 5 BS 5-button radio internal push button	27
--	----

 FES 1 BS Radio receiver electric socket	27
---	----

 FES 1-1 BS Radio receiver electric socket	27
---	----





## Garage door operators

# Hörmann Up-and-Over Doors



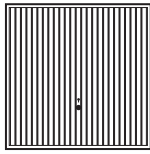
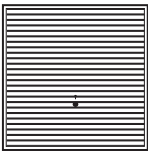
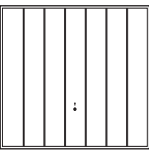
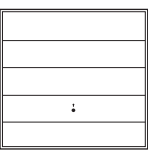

## Canopy & retractable with steel infill



SINGLE DOORS													
Door sizes BR		2001 Vertical		2002 Horizontal		2601 Elegance		2602 Finesse		2101 Ilkley		2103 Caxton	
Imperial	Metric	CAN.	RET.	CAN.	RET.	CAN.	RET.	CAN.	RET.	CAN.	RET.	CAN.	RET.
6'6" x 6'6"	1981 x 1981	545	587	478	520								
7'0"	1981 x 2134	545	587	478	520								
6'10" x 6'4"	2083 x 1930	544	586	490	532								
6'6"	2083 x 1981	544	586	501	543								
7'0"	2083 x 2134	558	600	519	561								
7'0" x 6'4"	2134 x 1930	546 <sup>1</sup>	588 <sup>1</sup>	496	538					914	956		
6'6"	<b>2134 x 1981</b>	<b>531<sup>1</sup></b>	<b>573<sup>1</sup></b>	<b>449<sup>1</sup></b>	<b>491<sup>1</sup></b>	<b>675</b>	<b>717</b>	<b>675</b>	<b>717</b>	<b>914</b>	<b>956</b>	<b>881</b>	<b>923</b>
7'0"	<b>2134 x 2134</b>	<b>551<sup>1</sup></b>	<b>593<sup>1</sup></b>	<b>502<sup>1</sup></b>	<b>544<sup>1</sup></b>	<b>713</b>	<b>755</b>	<b>713</b>	<b>755</b>	<b>924</b>	<b>966</b>	<b>888</b>	<b>930</b>
7'6"	2134 x 2286		683		638								
7'3" x 6'4"	2210 x 1930	574 <sup>1</sup>	616 <sup>1</sup>	539	581								
6'6"	2210 x 1981	577	619	542	584								
7'0"	2210 x 2134	584	626	548	590								
7'5" x 6'6"	2261 x 1981	581	623	539	581					949	991	934	976
7'0"	2261 x 2134	653	695	616	658					959	1001	943	985
7'6" x 6'4"	2286 x 1930	594	636	539	581					949	991		
6'6"	2286 x 1981	594 <sup>1</sup>	636 <sup>1</sup>	539 <sup>1</sup>	581 <sup>1</sup>	749	791	749	791	949	991	934	976
7'0"	2286 x 2134	653 <sup>1</sup>	695 <sup>1</sup>	618 <sup>1</sup>	660 <sup>1</sup>	864	906	864	906	959	1001	943	985
7'6"	2286 x 2286		743		764								
7'8" x 6'4"	2337 x 1930	674	716	621	663								
8'0" x 6'4"	2438 x 1930	705	747	622	664					1007	1049		
6'6"	2438 x 1981	705 <sup>1</sup>	747 <sup>1</sup>	622	664	888	930	888	930	1007	1049	967	1009
7'0"	2438 x 2134	730 <sup>1</sup>	772 <sup>1</sup>	635	677	924	966	924	966	1017	1059	1016	1058
7'6"	2438 x 2286		837		744								
8'0"	2438 x 2438		866		775								
8'6" x 6'6"	2590 x 1981		806		716								
7'0"	2590 x 2134		874		741								
9'0" x 6'6"	2743 x 1981		931		892								
7'0"	2743 x 2134		1017		936								
10'0" x 6'6"	3048 x 1981		1128		1118								
7'0"	3048 x 2134		1128		1118								
<b>Prices Marked <sup>1</sup> – optional Terra brown RAL 8028 available. Surcharge on door, see page 7.</b>													
DOUBLE DOORS Internal frame sizes BR		2001 Vertical		2002 Horizontal		2601 Elegance		2602 Finesse		2101 Ilkley		Style Not Available	
Imperial	Metric	Retractable		Retractable		Retractable		Retractable		Retractable			
11'0" x 6'6"	3353 x 1981	1226 *		1226 *									
7'0"	3353 x 2134	1236 *		1236 *									
12'0" x 6'6"	3658 x 1981	1288 *		1288 *									
7'0"	3658 x 2134	1298 *		1298 *									
13'0" x 6'6"	3962 x 1981	1402 *		1402 *									
7'0"	3962 x 2134	1433 *		1433 *									
14'0" x 6'6"	4267 x 1981	1350		1350						1869*			
7'0"	4267 x 2134	1350		1350						1869*			
<b>Prices Marked * – Not available ex-stock, delivery 4–5 weeks</b>													
MATCHING SIDE DOORS Ordering sizes		2001 Vertical		2002 Horizontal		2601 Elegance		2602 Finesse		Style Not Available		Style Not Available	
Prices Marked <sup>2</sup> – Not available ex-stock, delivery 4–8 weeks													
875 x 1875													
875 x 2000		368		740 <sup>2</sup>		692 <sup>2</sup>		692 <sup>2</sup>					
875 x 2125													
1000 x 2000		391		765 <sup>2</sup>		791 <sup>2</sup>		791 <sup>2</sup>					
1000 x 2125													

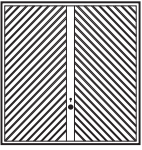



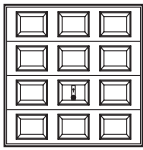

										75mm steel framed doors Recommended structural opening sizes allowing tolerance of 10mm on width & 5mm on height For steel frame options see page 7	
2003 Chevron		2004 Georgian		2304 Georgian with windows		2104 Marquess		2504 Countess		Imperial	Metric
CAN.	RET.	CAN.	RET.	CAN.	RET.	CAN.	RET.	CAN.	RET.		
		666	708							7'0" x 6'8½"	2135 x 2044
		677	719							7'0" x 7'2¾"	2135 x 2199
		674	716							7'4" x 6'6½"	2235 x 1994
		675	717							7'4" x 6'8½"	2235 x 2044
		724	766							7'4" x 7'2¾"	2235 x 2199
		675	717							7'6" x 6'6½"	2284 x 1994
567	609	675 <sup>1</sup>	717 <sup>1</sup>	928	970	675	717	675	717	7'6" x 6'8½"	2284 x 2044
604	646	713 <sup>1</sup>	755 <sup>1</sup>	967	1009	713	755	713	755	7'6" x 7'2¾"	2284 x 2199
										7'6" x 7'8½"	2284 x 2350
		749	791							7'9¼" x 6'6½"	2365 x 1994
										7'9¼" x 6'8½"	2365 x 2044
										7'9¼" x 7'2¾"	2365 x 2199
		749	791							7'11" x 6'8½"	2411 x 2044
		864	906							7'11" x 7'2¾"	2411 x 2199
		749	791							8'0" x 6'6½"	2436 x 1994
632	674	749 <sup>1</sup>	791 <sup>1</sup>	1002	1044	749	791	749	791	8'0" x 6'8½"	2436 x 2044
695	737	864 <sup>1</sup>	906 <sup>1</sup>	1118	1160	864	906	864	906	8'0" x 7'2¾"	2436 x 2199
										8'0" x 7'8½"	2436 x 2350
		899	941							8'2" x 6'6½"	2489 x 1994
		888	930							8'6" x 6'6½"	2589 x 1994
795	837	888	930			888	930			8'6" x 6'8½"	2589 x 2044
828	870	924	966			924	966			8'6" x 7'2¾"	2589 x 2199
										8'6" x 7'8½"	2589 x 2350
										8'6" x 8'2¾"	2589 x 2503
										9'0" x 6'8½"	2741 x 2044
										9'0" x 7'2¾"	2741 x 2199
			1174							9'6" x 6'8½"	2894 x 2044
			1195							9'6" x 7'2¾"	2894 x 2199
										10'6" x 6'8½"	3199 x 2044
										10'6" x 7'2¾"	3199 x 2199
2003 Chevron	2004 Georgian	2304 Georgian with windows	2104 Marquess	Style Not Available						Imperial	Metric
Retractable	Retractable	Retractable	Retractable								
										11'6" x 6'8½"	3504 x 2044
										11'6" x 7'2¾"	3504 x 2199
										12'6" x 6'8½"	3809 x 2044
										12'6" x 7'2¾"	3809 x 2199
										13'6" x 6'8½"	4114 x 2044
										13'6" x 7'2¾"	4114 x 2199
1773*	1454	1963*	1454*							14'6" x 6'8½"	4419 x 2044
1773*	1454	1963*	1454*							14'6" x 7'2¾"	4419 x 2199
2003 Chevron	2004 Georgian	2304 Georgian with windows	2104 Marquess	Style Not Available							
929 <sup>2</sup>	692 <sup>2</sup>	801 <sup>2</sup>	692 <sup>2</sup>								
944 <sup>2</sup>	791 <sup>2</sup>	899 <sup>2</sup>	791 <sup>2</sup>								

# Hörmann Up-and-Over Doors

## Canopy & retractable with steel infill

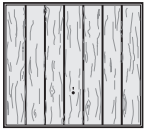
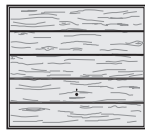
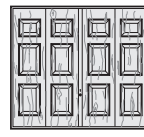

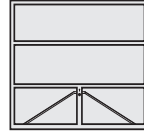
SINGLE DOORS											
Door sizes BR		Vertical Decograin Golden Oak or Rosewood		Horizontal Decograin Golden Oak or Rosewood		Georgian Decograin Golden Oak or Rosewood		Marquess Decograin Golden Oak or Rosewood		2011 Open for infill	
Imperial	Metric	CAN.	RET.	CAN.	RET.	CAN.	RET.	CAN.	RET.	CAN.	RET.
6'6" x 6'6"	1981 x 1981									460	502
7'0"	1981 x 2134									460	502
6'10" x 6'4"	2083 x 1930									460	502
6'6"	2083 x 1981										
7'0"	2083 x 2134										
7'0" x 6'4"	2134 x 1930									460	502
6'6"	<b>2134 x 1981</b>	<b>685</b>	<b>727</b>	<b>609</b>	<b>651</b>	<b>808</b>	<b>850</b>	<b>808</b>	<b>850</b>	460	502
7'0"	<b>2134 x 2134</b>	<b>705</b>	<b>747</b>	<b>659</b>	<b>701</b>	<b>847</b>	<b>889</b>	<b>847</b>	<b>889</b>	490	532
7'6"	2134 x 2286										
7'3" x 6'4"	2210 x 1930									513	555
6'6"	2210 x 1981										
7'0"	2210 x 2134										
7'5" x 6'6"	2261 x 1981	731	773	675	717	902	944	902	944	513	555
7'0"	2261 x 2134	787	829	752	794	1039	1081	1039	1081	528	570
7'6" x 6'4"	2286 x 1930									513	555
6'6"	2286 x 1981	731	773	675	717	899	941	899	941	513	555
7'0"	2286 x 2134	787	829	752	794	1039	1081	1039	1081	527	569
7'6"	2286 x 2286										
7'8" x 6'4"	2337 x 1930									536	578
8'0" x 6'4"	2438 x 1930									536	578
6'6"	2438 x 1981	842	884	745	787	1057	1099	1057	1099	536	578
7'0"	2438 x 2134	867	909	773	815	1094	1136	1094	1136	536	578
7'6"	2438 x 2286										
8'0"	2438 x 2438										
8'6" x 6'6"	2590 x 1981										
7'0"	2590 x 2134										
9'0" x 6'6"	2743 x 1981										637
7'0"	2743 x 2134										647
10'0" x 6'6"	3048 x 1981										1150
7'0"	3048 x 2134										1150
DOUBLE DOORS Internal frame sizes BR		Style Not Available		Style Not Available		Style Not Available		Style Not Available		2011 Open for infill	
Imperial	Metric									Retractable	
11'0" x 6'6"	3353 x 1981										1554
7'0"	3353 x 2134										1623
12'0" x 6'6"	3658 x 1981										1645
7'0"	3658 x 2134										1707
13'0" x 6'6"	3962 x 1981										1727
7'0"	3962 x 2134										1782
14'0" x 6'6"	4267 x 1981										1614
7'0"	4267 x 2134										1614
<b>Prices Marked * - Not available ex-stock, delivery 4-5 weeks</b>											
MATCHING SIDE DOORS Ordering sizes		2001 Golden Oak or Rosewood		2002 Golden Oak or Rosewood		2004 Golden Oak or Rosewood		2104 Golden Oak or Rosewood		2011 Open for infill	
<b>Prices Marked <sup>2</sup> - Not available ex-stock, delivery 4-8 weeks</b>											
875 x 1875											
875 x 2000		764 <sup>2</sup>		764 <sup>2</sup>		764 <sup>2</sup>		764 <sup>2</sup>		368	
875 x 2125											
1000 x 2000		878 <sup>2</sup>		878 <sup>2</sup>		878 <sup>2</sup>		878 <sup>2</sup>		391	
1000 x 2125											



The door leaf and optional box section steel frame are made of galvanised material that is polyester powder coated on both sides.

This finish is extremely durable and the standard colour is Traffic white RAL 9016.

Other colours are available listed in optional extras below.

To help maintain the aesthetic appearance of your door and prevent the build up of dirt, salt and other corrosive substances the door should be washed with a mild soap-based solution on a regular basis.

If the door is located near the coast it is important that the door panel and frame should be washed at least every 2 months.

We also suggest that all other components are brushed down on a regular basis to prevent the build up of dirt and dust etc.

The window frames on the Georgian and Ilkley doors are UPVC and white as standard.

These frames are a 2-part construction with the window material sandwiched between and frames screwed together from the back for security.

The finish of the Decograin doors is a synthetic foil-coated timber design outside (inside primer white).

The leaf frame and fixing frame is a matching powder coating.



**For further choice of exciting door designs in steel, traditional or contemporary, with a vast range of sizes and increased range of colours, ask your garage door specialist about the N 80 Up-and-Over garage doors available to special order.**

Optional extras for Steel Doors	Price
<b>75mm</b> Steel fixing frame for either canopy or retractable geared single doors. Factory fitted	<b>100</b>
<b>75mm</b> Steel fixing frame for either canopy or retractable geared single doors. Factory fitted with frame to compliment Decograin	<b>100</b>
<b>75mm</b> Steel fixing frame for <b>DOUBLE</b> retractable geared doors, when ordered with the door	<b>158</b>
<b>60mm</b> Steel fixing frame for canopy geared doors only. Factory fitted	<b>103</b>
<b>60mm</b> Steel fixing frame for canopy geared doors only. Factory fitted with frame to compliment Decograin	<b>103</b>
<b>Please note:</b> Factory fitted 8' high frame not available	
Prices marked <sup>1</sup> – optional Terra Brown RAL 8028 available. Surcharge on door	<b>27</b>
Retractable plus gear for retractable doors up to 7'6" wide giving extra drive through width	
Surcharge on retractable price	<b>51</b>
4 point locking kit for extra security, factory fit with door order or retrofit – single door sizes only	<b>46</b>
3 point locking kit for extra security, factory fit with door (this cannot be retrofitted). Available for 2001 side doors only	<b>92</b>
Window options for 2304 Georgian style door – Plain, crossed or diamond style with crystal glazing	<b>Incl.</b>
<b>Colours are available to special order in the following styles:</b>	
2001 Vertical, 2002 Horizontal, 2101 Ilkley available in all the listed sizes	
2004 Georgian, 2304 Georgian with windows and 2104 Marquess are available in 7066, 7070, 7566, 7570, 7666, 7670 and 8066, 8070 sizes only	
<b>Please note:</b> Caxton, Chevron, Elegance, Finesse and Countess steel up-and-over doors are only available in white	
<b>Colours:</b>	
Terra Brown RAL 8028, Signal Blue RAL 5005, Steel Blue RAL 5011, Moss Green RAL 6005, Ruby Red RAL 3003, Jet Black RAL 9005	
Includes matching frame if ordered with door. White frame RAL 9016 also available, please specify when ordering	
Please allow 3–4 weeks lead time for coloured doors	
	Single doors <b>95</b>
	Double doors <b>153</b>
<b>Coloured window frames for Georgian and Ilkley doors:</b>	
Coloured window frames to match door colour	
Georgian doors (price per window, see note below for the number of windows)	<b>28</b>
Ilkley doors (price per single door)	<b>133</b>
Ilkley doors (price per double door)	<b>266</b>
Please state coloured windows required on order	
Orders received without reference will be supplied with white as standard	
Georgian doors up to 10' wide = 4 windows, 11' to 13' = 6 windows, 14' = 8 windows	
<b>Optional handle sets</b>	
Cast Aluminium silver colour and brass colour	<b>112</b>
Cast Aluminium white and brown	<b>134</b>
Brushed or polished stainless steel	<b>162</b>
Matching lever handles are also available for side doors	<b>P.O.A.</b>

# Hörmann Up-and-Over Doors



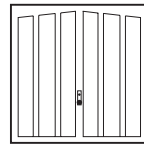
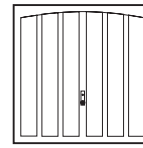
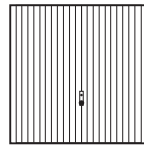

## Canopy & retractable with timber infill



SINGLE DOORS											
Door sizes BR		2005 Measham		2007 Jacobean		2008 Tudor		2014 Rutland		2009 Vertical or Horizontal	
Imperial	Metric	CAN.	RET.	CAN.	RET.	CAN.	RET.	CAN.	RET.	CAN.	RET.
6'6" x 6'6"	1981 x 1981	968	1010	1169	1211	1169	1211	1169	1211	1335	1377
7'0"	1981 x 2134	968	1010	1169	1211	1169	1211	1169	1211	1335	1377
6'10" x 6'4"	2083 x 1930	968	1010	1169	1211	1169	1211	1169	1211	1335	1377
6'6"	2083 x 1981										
7'0"	2083 x 2134										
7'0" x 6'4"	2134 x 1930	968	1010	1169	1211	1169	1211	1169	1211	1335	1377
6'6"	<b>2134 x 1981</b>	<b>968</b>	<b>1010</b>	<b>1169</b>	<b>1211</b>	<b>1169</b>	<b>1211</b>	<b>1169</b>	<b>1211</b>	<b>1335</b>	<b>1377</b>
7'0"	<b>2134 x 2134</b>	<b>968</b>	<b>1010</b>	<b>1169</b>	<b>1211</b>	<b>1169</b>	<b>1211</b>	<b>1169</b>	<b>1211</b>	<b>1335</b>	<b>1377</b>
7'6"	2134 x 2286										
7'3" x 6'4"	2210 x 1930	1006	1048	1224	1266	1224	1266	1224	1266	1384	1426
6'6"	2210 x 1981										
7'0"	2210 x 2134										
7'5" x 6'6"	2261 x 1981	1006	1048	1224	1266	1224	1266	1224	1266	1384	1426
7'0"	2261 x 2134	1083	1125	1263	1305	1263	1305	1263	1305	1416	1458
7'6" x 6'4"	2286 x 1930	1006	1048	1224	1266	1224	1266	1224	1266	1384	1426
6'6"	2286 x 1981	1006	1048	1224	1266	1224	1266	1224	1266	1384	1426
7'0"	2286 x 2134	1030	1072	1263	1305	1263	1305	1263	1305	1416	1458
7'6"	2286 x 2286										
8'0"	2286 x 2438										
7'8" x 6'4"	2337 x 1930	1045	1087	1279	1321	1279	1321	1279	1321	1384	1426
8'0" x 6'4"	2438 x 1930	1063	1105	1293	1335	1293	1335	1293	1335	1464	1506
6'6"	2438 x 1981	1063	1105	1293	1335	1293	1335	1293	1335	1464	1506
7'0"	2438 x 2134	1086	1128	1326	1368	1326	1368	1326	1368	1506	1548
8'0"	2438 x 2438										
8'6" x 6'6"	2590 x 1981										
7'0"	2590 x 2134										
9'0" x 6'6"	2743 x 1981		1295		1501		1501		1501		1603
7'0"	2743 x 2134		1295		1501		1501		1501		1603
10'0" x 6'6"	3048 x 1981		1300		1604		1604		1604		1676
7'0"	3048 x 2134		1300		1604		1604		1604		1676
DOUBLE DOORS Internal frame sizes BR		2005 Measham		2007 Jacobean		2008 Tudor		2014 Rutland		2009 Vertical or Horizontal	
Imperial	Metric	CAN.	RET.	CAN.	RET.	CAN.	RET.	CAN.	RET.	CAN.	RET.
11'0" x 6'6"	3353 x 1981		2293		2529		2529		2529		2701
7'0"	3353 x 2134		2293		2529		2529		2529		2701
12'0" x 6'6"	3658 x 1981		2379		2542		2542		2542		2986
7'0"	3658 x 2134		2379		2542		2542		2542		2986
13'0" x 6'6"	3962 x 1981		2388		2742		2742		2742		3339
7'0"	3962 x 2134		2388		2742		2742		2742		3339
14'0" x 6'6"	4267 x 1981		2393		2699		2699		2699		2797
7'0"	4267 x 2134		2393		2699		2699		2699		2797
<b>Please note: Lead times on all timber garage doors will be 5 to 6 weeks</b>											
MATCHING SIDE DOORS Ordering sizes		2005 Measham		2007 Jacobean		2008 Tudor		2014 Rutland		2009 Vertical or Horizontal	
<b>Please note: Lead times on all timber side garage doors will be 5 to 6 weeks</b>											
875 x 1875											
875 x 2000		657		760		760		760		769	
875 x 2125											
1000 x 2000											
1000 x 2125		690		792		792		792		803	

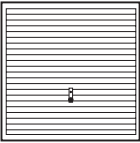



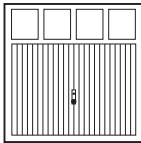



										<b>75mm steel framed doors</b> <b>Recommended structural opening sizes allowing tolerance of 10mm on width &amp; 5mm on height</b> <b>For steel frame options see page 11</b>	
<b>2109 Mallory</b> Horizontal or Vertical		<b>2013 Caxton</b>		<b>2020 Gatcombe</b>		<b>2114 Shepshed</b>		<b>2019 Garage Light</b>		Imperial	Metric
CAN.	RET.	CAN.	RET.	CAN.	RET.	CAN.	RET.	CAN.	RET.		
1332	1374	1547	1589	1547	1589	1547	1589	1599	1641	7'0" x 6'8½"	2135 x 2044
1332	1374	1547	1589	1547	1589	1547	1589	1599	1641	7'0" x 7'2¾"	2135 x 2199
1332	1374	1547	1589	1547	1589	1547	1589	1599	1641	7'4" x 6'6½"	2235 x 1994
										7'4" x 6'8½"	2235 x 2044
										7'4" x 7'2¾"	2235 x 2199
1332	1374	1547	1589	1547	1589	1547	1589	1599	1641	7'6" x 6'6½"	2284 x 1994
<b>1332</b>	<b>1374</b>	<b>1547</b>	<b>1589</b>	<b>1547</b>	<b>1589</b>	<b>1547</b>	<b>1589</b>	<b>1599</b>	<b>1641</b>	<b>7'6" x 6'8½"</b>	<b>2284 x 2044</b>
<b>1332</b>	<b>1374</b>	<b>1547</b>	<b>1589</b>	<b>1547</b>	<b>1589</b>	<b>1547</b>	<b>1589</b>	<b>1599</b>	<b>1641</b>	<b>7'6" x 7'2¾"</b>	<b>2284 x 2199</b>
										7'6" x 7'8½"	2284 x 2350
1384	1426	1597	1639	1597	1639	1597	1639	1669	1711	7'9¼" x 6'6½"	2365 x 1994
										7'9¼" x 6'8½"	2365 x 2044
										7'9¼" x 7'2¾"	2365 x 2199
1384	1426	1597	1639	1597	1639	1597	1639	1669	1711	7'11" x 6'8½"	2411 x 2044
1436	1478	1622	1664	1622	1664	1622	1664	1712	1754	7'11" x 7'2¾"	2411 x 2199
1384	1426	1597	1639	1597	1639	1597	1639	1669	1711	8'0" x 6'6½"	2436 x 1994
1384	1426	1597	1639	1597	1639	1597	1639	1669	1711	8'0" x 6'8½"	2436 x 2044
1436	1478	1622	1664	1622	1664	1622	1664	1747	1789	8'0" x 7'2¾"	2436 x 2199
										8'0" x 7'8½"	2436 x 2350
										8'0" x 8'2¾"	2436 x 2503
1523	1565	1751	1793	1751	1793	1751	1793	1873	1915	8'2" x 6'6½"	2489 x 1994
1523	1565	1751	1793	1751	1793	1751	1793	1873	1915	8'6" x 6'6½"	2589 x 1994
1523	1565	1751	1793	1751	1793	1751	1793	1873	1915	8'6" x 6'8½"	2589 x 2044
1523	1565	1751	1793	1751	1793	1751	1793	1873	1915	8'6" x 7'2¾"	2589 x 2199
										8'6" x 8'2¾"	2589 x 2503
										9'0" x 6'8½"	2741 x 2044
										9'0" x 7'2¾"	2741 x 2199
	1761		2010		2010		2010		2065	9'6" x 6'8½"	2894 x 2044
	1761		2010		2010		2010		2065	9'6" x 7'2¾"	2894 x 2199
	1920		2139		2139		2139		2295	10'6" x 6'8½"	3199 x 2044
	1920		2139		2139		2139		2295	10'6" x 7'2¾"	3199 x 2199
<b>2109 Mallory</b>	<b>2013 Caxton</b>		<b>2020 Gatcombe</b>		<b>2114 Shepshed</b>		<b>2019 Garage Light</b>		Imperial	Metric	
CAN.	RET.	CAN.	RET.	CAN.	RET.	CAN.	RET.	CAN.	RET.		
	2842		3001		3001		3001		3341	11'6" x 6'8½"	3504 x 2044
	2842		3001		3001		3001		3341	11'6" x 7'2¾"	3504 x 2199
	3083		3263		3263		3263		3674	12'6" x 6'8½"	3809 x 2044
	3083		3263		3263		3263		3674	12'6" x 7'2¾"	3809 x 2199
	3344		3566		3566		3566		4138	13'6" x 6'8½"	4114 x 2044
	3344		3566		3566		3566		4138	13'6" x 7'2¾"	4114 x 2199
	3248		3468		3468		3468		3921	14'6" x 6'8½"	4419 x 2044
	3248		3468		3468		3468		3921	14'6" x 7'2¾"	4419 x 2199
<b>2109 Mallory</b>	<b>2013 Caxton</b>		<b>2020 Gatcombe</b>		<b>2114 Shepshed</b>		<b>2019 Garage Light</b>				
	867		897		915		892		1022		
	902		932		952		926		1054		

# Hörmann Up-and-Over Doors

## Canopy & retractable with timber infill

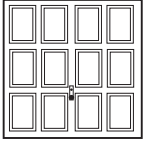

SINGLE DOORS										75mm steel framed doors Recommended structural opening sizes allowing tolerance of 10mm on width & 5mm on height For steel frame options see page 11	
Door sizes BR		2119 Leicester		2010 Chevron		2121 Chesterfield		2122 Middleton		Imperial	Metric
Imperial	Metric	CAN.	RET.	CAN.	RET.	CAN.	RET.	CAN.	RET.		
6'6" x 6'6"	1981 x 1981		1853	1652	1694		2117		2100	7'0" x 6'8½"	2135 x 2044
7'0"	1981 x 2134		1853	1652	1694		2117		2100	7'0" x 7'2¾"	2135 x 2199
6'10" x 6'4"	2083 x 1930		1853	1652	1694		2117		2100	7'4" x 6'6½"	2235 x 1994
6'6"	2083 x 1981									7'4" x 6'8½"	2235 x 2044
7'0"	2083 x 2134									7'4" x 7'2¾"	2235 x 2199
7'0" x 6'4"	2134 x 1930		1867	1652	1694		2117		2100	7'6" x 6'6½"	2284 x 1994
6'6"	<b>2134 x 1981</b>		<b>1867</b>	<b>1652</b>	<b>1694</b>		<b>2117</b>		<b>2100</b>	<b>7'6" x 6'8½"</b>	<b>2284 x 2044</b>
7'0"	<b>2134 x 2134</b>		<b>1867</b>	<b>1652</b>	<b>1694</b>		<b>2132</b>		<b>2124</b>	<b>7'6" x 7'2¾"</b>	<b>2284 x 2199</b>
7'6"	2134 x 2286									7'6" x 7'8½"	2284 x 2350
7'3" x 6'4"	2210 x 1930		2036	1726	1768		2273		2266	7'9¼" x 6'6½"	2365 x 1994
6'6"	2210 x 1981									7'9¼" x 6'8½"	2365 x 2044
7'0"	2210 x 2134									7'9¼" x 7'2¾"	2365 x 2199
7'5" x 6'6"	2261 x 1981		2045	1726	1768		2277		2266	7'11" x 6'8½"	2411 x 2044
7'0"	2261 x 2134		2124	1773	1815		2287		2277	7'11" x 7'2¾"	2411 x 2199
7'6" x 6'4"	2286 x 1930		2043	1726	1768		2277		2266	8'0" x 6'6½"	2436 x 1994
6'6"	2286 x 1981		2043	1726	1768		2277		2266	8'0" x 6'8½"	2436 x 2044
7'0"	2286 x 2134		2124	1773	1815		2300		2287	8'0" x 7'2¾"	2436 x 2199
7'6"	2286 x 2286									8'0" x 7'8½"	2436 x 2350
8'0"	2286 x 2438									8'2" x 6'6½"	2436 x 2503
7'8" x 6'4"	2337 x 1930		2180	1886	1928					8'6" x 6'6½"	2489 x 1994
8'0" x 6'4"	2438 x 1930		2187	1886	1928					8'6" x 6'8½"	2589 x 1994
6'6"	2438 x 1981		2187	1886	1928					8'6" x 7'2¾"	2589 x 2044
7'0"	2438 x 2134		2236	1916	1958					8'6" x 7'8½"	2589 x 2199
8'0"	2438 x 2438									8'6" x 8'2¾"	2589 x 2503
8'6" x 6'6"	2590 x 1981									9'0" x 6'8½"	2741 x 2044
7'0"	2590 x 2134									9'0" x 7'2¾"	2741 x 2199
9'0" x 6'6"	2743 x 1981		2292		2085					9'6" x 6'8½"	2894 x 2044
7'0"	2743 x 2134		2292		2085					9'6" x 7'2¾"	2894 x 2199
10'0" x 6'6"	3048 x 1981		2582		2427					10'6" x 6'8½"	3199 x 2044
7'0"	3048 x 2134		2582		2427					10'6" x 7'2¾"	3199 x 2199
DOUBLE DOORS Internal Frame Sizes BR		2119 Leicester		2010 Chevron		Style Not Available		Style Not Available		Imperial	Metric
BR	RET.	CAN.	RET.	CAN.	RET.	CAN.	RET.	CAN.	RET.		
11'0" x 6'6"	3353 x 1981		3599		3444					11'6" x 6'8½"	3504 x 2044
7'0"	3353 x 2134		3599		3444					11'6" x 7'2¾"	3504 x 2199
12'0" x 6'6"	3658 x 1981		3848		3508					12'6" x 6'8½"	3809 x 2044
7'0"	3658 x 2134		3848		3508					12'6" x 7'2¾"	3809 x 2199
13'0" x 6'6"	3962 x 1981		4211		3566					13'6" x 6'8½"	4114 x 2044
7'0"	3962 x 2134		4211		3566					13'6" x 7'2¾"	4114 x 2199
14'0" x 6'6"	4267 x 1981		4108		3468					14'6" x 6'8½"	4419 x 2044
7'0"	4267 x 2134		4108		3468					14'6" x 7'2¾"	4419 x 2199
<b>Please note: Lead times on all timber garage doors will be 5 to 6 weeks</b>											
MATCHING SIDE DOORS Ordering Sizes		2119 Leicester		2010 Chevron		2121 Chesterfield		2122 Middleton			
<b>Please note: Lead times on all timber side garage doors will be 5 to 6 weeks</b>											
875 x 1875											
875 x 2000			783		760		760		783		
875 x 2125											
1000 x 2000			803		792		792		803		
1000 x 2125											



Our timber garage doors are constructed as an infill to fit into the Open-for-Infill Up-and-Over door frame, this gives the doors their rigid and durable construction.

The styles Measham, Jacobean, Tudor and Rutland are cedar facings glued and fixed to exterior quality plywood.

The solid cedar doors are 12mm tongue and groove boards constructed as an infill.

Cedar is organically grown with natural colour and grain variations; this is a feature of cedar.

We make every effort to harmonise the effect where possible, by hand matching the component parts used in construction.

Please note a uniform overall grain pattern cannot be guaranteed.

#### Protection (Basecoat)

All our timber doors are supplied with a dip immersion coat of Remmers Induline GW306 base stain primer 006 Light Oak; this coating is for temporary protection only.

If purchased in this temporary finish, please ensure that a full specification of finishing coats are applied immediately before or after installation to all exposed surfaces - inside as well as outside - with a Remmers or similar finishing coat system.

**A fully finished option is available, please see options below.**

**For further choice of exciting door designs, traditional or contemporary in Nordic Pine and Hemlock, with a vast range of sizes, ask your garage door specialist about the N80 Up-and-Over garage doors available to special order.**

Optional extras for timber doors	Price	
75mm Steel fixing frame for either canopy or retractable geared single doors, factory fitted Terra brown RAL 8028 as standard	100	
75mm Steel fixing frame for <b>DOUBLE</b> retractable geared doors Terra brown RAL 8028 as standard when ordered with the door	158	
60mm Steel fixing frame for canopy geared doors only, factory fitted Terra brown RAL 8028 as standard	103	
<b>Please note:</b> Factory fitted 8' high frame not available		
Retractable plus gear for retractable doors up to 7'6" wide giving extra drive through width Surcharge on retractable price	51	
4 point locking kit for extra security, factory fit with door order or retrofit	46	
Window options for 2019 Garage Light door - Crystal or clear glazing and can be plain or with square or diamond simulated leading	Incl.	
Over cladding of the OFI chassis (not available in combination with retractable plus)	Single 65	Double 130

#### Fully finished option

This is available as a factory process giving a 5 year erosion protection

The product used is Remmers and is available in the following stain colours:

Mahogany, Walnut, Dark Oak, Medium Oak, Light Oak, Teak, Ebony, Rosewood and Golden Oak

For south facing situations exposed to strong sunlight, the dark colours are NOT recommended as they can store excessive heat and dry out

	Stain finish	Traffic white RAL 9016	RAL to choose
Door sizes up to 8'0" x 7'0"	107	184	245
Door sizes up to 14'0" x 7'0"	245	332	609
Side Doors	79	166	208



#### Optional handle sets

Cast Aluminium silver colour and brass colour	112
Cast Aluminium white and brown	134
Brushed or polished stainless steel	162
Matching lever handles are also available for side doors	P.O.A.

# Hörmann Up-and-Over Doors

## Canopy & retractable with GRP infill

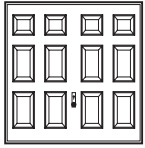

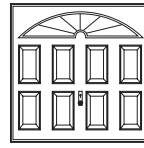
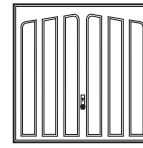
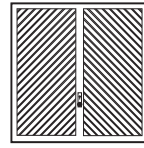
SINGLE DOORS											
Door sizes BR		2042 Windermere		2041 Coniston		2044 Stamford		2034 Penshurst		2035 Hartfield	
Imperial	Metric	CAN.	RET.	CAN.	RET.	CAN.	RET.	CAN.	RET.	CAN.	RET.
7'0" x 6'6"	2134 x 1981	1598	1640	1563	1605	1641	1683	1694	1736	1694	1736
7'0"	2134 x 2134	1598	1640	1563	1605	1641	1683	1694	1736	1694	1736
7'6" x 6'6"	2286 x 1981	1694	1736	1651	1693	1728	1770	1842	1884	1842	1884
7'0"	2286 x 2134	1694	1736	1651	1693	1728	1770	1842	1884	1842	1884
8'0" x 6'6"	2438 x 1981	1822	1864	1802	1844	1871	1913	1961	2003		
7'0"	2438 x 2134	1822	1864	1802	1844	1871	1913	1961	2003		
9'0" x 6'6"	2743 x 1981		2053*		2006*		2072*		2113		
7'0"	2743 x 2134		2053*		2006*		2072*		2113		

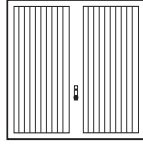
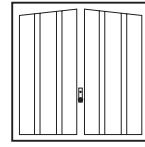
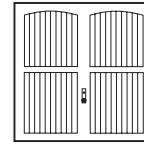
SINGLE DOORS & DOUBLE DOORS									
Door sizes BR		2040 Livingston		2047 Bourton		2048 Burford		2049 Moreton	
Imperial	Metric	CAN.	RET.	CAN.	RET.	CAN.	RET.	CAN.	RET.
7'0" x 6'6"	2134 x 1981	1873	1915	1694	1736	1694	1736	1873	1915
7'0"	2134 x 2134	1873	1915	1694	1736	1694	1736	1873	1915
7'6" x 6'6"	2286 x 1981	2023	2065	1842	1884	1842	1884	2023	2065
7'0"	2286 x 2134	2023	2065	1842	1884	1842	1884	2023	2065
8'0" x 6'6"	2438 x 1981			1961	2003	1961	2003	2140	2182
7'0"	2438 x 2134			1961	2003	1961	2003	2140	2182
14'0" x 6'6"	4267 x 1981				3109		3374		3388
7'0"	4267 x 2134				3109		3374		3388

Coniston and Stamford are supplied in white RAL 9016 OFI, all other styles are supplied in Terra brown RAL 8028 OFI.

### 75mm steel framed doors

Door sizes BR		Recommended structural opening sizes allowing tolerance of 10mm on width & 5mm on height	
Imperial	Metric	Imperial	Metric
7'0" x 6'6"	2134 x 1981	7'6" x 6'8½"	2284 x 2044
7'0" x 7'0"	2134 x 2134	7'6" x 7'2¾"	2284 x 2199
7'6" x 6'6"	2286 x 1981	8'0" x 6'8½"	2436 x 2044
7'6" x 7'0"	2286 x 2134	8'0" x 7'2¾"	2436 x 2199
8'0" x 6'6"	2438 x 1981	8'6" x 6'8½"	2589 x 2044
8'0" x 7'0"	2438 x 2134	8'6" x 7'2¾"	2589 x 2199
9'0" x 6'6"	2743 x 1981	9'6" x 6'8½"	2894 x 2044
9'0" x 7'0"	2743 x 2134	9'6" x 7'2¾"	2894 x 2199

For GRP colour options please consult main brochure

Window Options	Price
Clear or translucent	Per door 158
Clear or translucent with decorative leading	Per door 263

Windows are available in the Windermere and Coniston (clear or translucent) Stamford comes with black windows as standard

\* Doors only available without handle (automation required)

# Hörmann Sectional Doors



## Door sizes

Large range of standard sizes is supplemented with intermediate widths and heights available by modification at Hörmann's UK headquarters. Please consult with your Hörmann UK specialist installer.

## Secured by design

- LPU40 sectional doors are certified SBD when fitted with a ProMatic or SupraMatic BiSecur operator
- A unique mechanical latch, integral to the operator boom engages automatically to make the door impossible to lever open
- Doors with windows and ventilation grilles, manually operated doors, or doors fitted between the opening are excluded from SBD certification
- Copies of SBD and test certification are available, if required, via the Hörmann UK Marketing Department

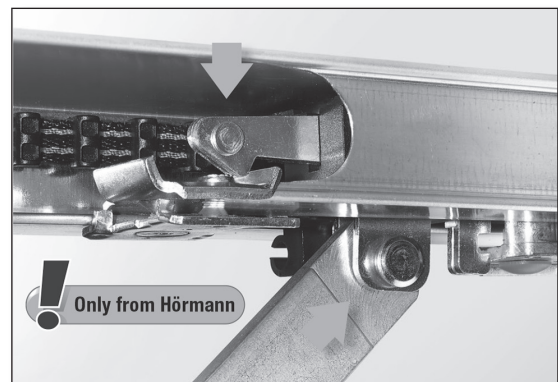

**For further information on Secured by Design see our brochure.**

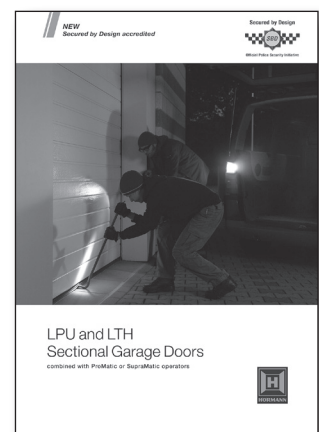





# Hörmann Sectional Doors

## LTE 40 – single-skinned doors with steel sections

Single doors with Z track tension springs giving low headroom as standard

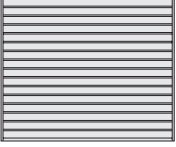

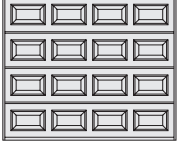
SINGLE DOORS								No. of panels
Door sizes BR		S-ribbed Woodgrain		M-ribbed Woodgrain		S-panelled Woodgrain		
Imperial	Metric	Outside White	Outside Colour	Outside White	Outside Colour	Outside White	Outside Colour	
6'10" x 6'2"	2080 x 1875	639	784	639	784	716	861	4
6'10" x 6'10"	2080 x 2080	669	830	669	830	741	902	4
7'0" x 6'6"	2134 x 2000	652	810	652	810	729	887	4
7'0" x 7'0"	2134 x 2125	669	837	669	837	741	909	4
7'6" x 6'6"	2286 x 2000	652	822	652	822	729	899	4
7'6" x 7'0"	2286 x 2125	669	849	669	849	741	921	4
7'6" x 7'4"	2286 x 2250	705	896	705	896	774	965	4
7'6" x 7'9"	2286 x 2375	813	1014	813	1014	889	1090	4
7'6" x 8'2"	2286 x 2500	813	1025	813	1025	889	1101	4
8'0" x 6'6"	2438 x 2000	678	859	678	859	756	937	4
8'0" x 7'0"	2438 x 2125	702	894	702	894	769	961	4
8'0" x 7'4"	2438 x 2250	739	942	739	942	804	1007	4
8'0" x 7'9"	2438 x 2375	845	1060	845	1060	916	1131	4
8'0" x 8'2"	2438 x 2500	846	1072	846	1072	916	1142	4
8'6" x 6'6"	2591 x 2000	678	870	678	870	756	948	4
8'6" x 7'0"	2591 x 2125	702	906	702	906	769	973	4
9'0" x 6'6"	2740 x 2000	764	967	764	967	876	1079	4
9'0" x 7'0"	2740 x 2125	787	1003	787	1003	892	1108	4
9'6" x 6'6"	2896 x 2000	789	1004	789	1004	919	1134	5
9'6" x 7'0"	2896 x 2125	818	1046	818	1046	934	1162	5
10'0" x 6'6"	3048 x 2000	789	1015	789	1015	919	1145	5
10'0" x 7'0"	3048 x 2125	818	1058	818	1058	934	1174	5

For information on outside colour, see page 17

## Double doors with N track torsion springs (for low headroom see bottom of page 17)

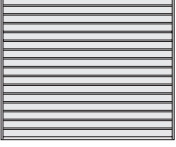
DOUBLE DOORS			
Door sizes BR		S-ribbed Woodgrain	
Imperial	Metric	Outside White	Outside Colour
11'0" x 6'6"	3353 x 2000	1101	1350
11'0" x 7'0"	3353 x 2125	1140	1404
12'0" x 6'6"	3658 x 2000	1217	1488
12'0" x 7'0"	3658 x 2125	1267	1555
13'0" x 6'6"	3962 x 2000	1243	1537
13'0" x 7'0"	3962 x 2125	1293	1605
14'0" x 6'6"	4267 x 2000	1348	1664
14'0" x 7'0"	4267 x 2125	1419	1755
14'6" x 6'6"	4420 x 2000	1378	1706
14'6" x 7'0"	4420 x 2125	1450	1798
15'0" x 6'6"	4572 x 2000	1384	1723
15'0" x 7'0"	4572 x 2125	1456	1816
15'6" x 6'6"	4725 x 2000	1426	1776
15'6" x 7'0"	4725 x 2125	1499	1871
16'0" x 6'6"	4877 x 2000	1425	1786
16'0" x 7'0"	4877 x 2125	1499	1883





Prices Marked 2 – Not available ex-stock, delivery 4–8 weeks

# Hörmann Sectional Doors

## LPU 40 – double-skinned doors with steel sections – 42mm

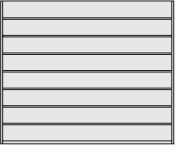

Single doors with Z track tension springs giving low headroom as standard



SINGLE DOORS									
Door sizes BR		S-ribbed Woodgrain/ M-ribbed Woodgrain		M-ribbed Sandgrain		M-ribbed Silkgrain		M-ribbed Decograin	
Imperial	Metric	Outside White	Outside Colour	Outside White	Anthracite grey Terra brown White aluminium	Outside White	Outside Colour	Rosewood, Golden Oak, Dark Oak, Winchester Oak, Night Oak	
6'10" x 6'2"	2080 x 1875	753	898	801	946	919	1064	1010	
6'6"	2080 x 2000	786	940	838	992	962	1116	1057	
6'10"	2080 x 2080	815	976	870	1031	998	1159	1097	
7'0" x 6'6"	2134 x 2000	813	971	838	996	962	1120	1057	
7'0"	2134 x 2125	841	1009	870	1038	998	1166	1097	
7'6" x 6'6"	2286 x 2000	813	983	838	1008	962	1132	1057	
7'0"	2286 x 2125	841	1021	870	1050	998	1178	1097	
7'4"	2286 x 2250	853	1044	912	1103	1047	1238	1151	
7'9"	2286 x 2375	918	1119	950	1151	1091	1292	1200	
8'2"	2286 x 2500	917	1129	986	1198	1134	1346	1248	
8'0" x 6'6"	2438 x 2000	854	1035	884	1065	1018	1199	1120	
7'0"	2438 x 2125	887	1079	922	1114	1061	1253	1168	
7'4"	2438 x 2250	894	1097	952	1155	1095	1298	1205	
7'9"	2438 x 2375	961	1176	993	1208	1143	1358	1259	
8'2"	2438 x 2500	959	1185	1036	1262	1196	1422	1318	
8'6" x 6'6"	2591 x 2000	854	1046	884	1076	1018	1210	1120	
7'0"	2591 x 2125	887	1091	922	1126	1061	1265	1168	
9'0" x 6'6"	2740 x 2000	925	1128	963	1166	1115	1318	1230	
7'0"	2740 x 2125	955	1171	1001	1217	1158	1374	1278	
9'6" x 6'6"	2896 x 2000	966	1181	1012	1227	1173	1388	1297	
7'0"	2896 x 2125	1003	1231	1052	1280	1219	1447	1348	
10'0" x 6'6"	3048 x 2000	933	1159	1012	1238	1173	1399	1297	
7'0"	3048 x 2125	965	1205	1052	1292	1219	1459	1348	

For information on outside colour, see page 17

### Double doors with N track torsion springs (for low headroom see bottom of page 17)

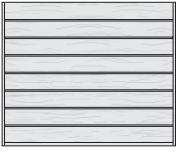
DOUBLE DOORS									
Door sizes BR		S-ribbed Woodgrain/ M-ribbed Woodgrain		M-ribbed Sandgrain		M-ribbed Silkgrain		M-ribbed Decograin	
Imperial	Metric	Outside White	Outside Colour	Outside White	Anthracite grey Terra brown White aluminium	Outside White	Outside Colour	Rosewood, Golden Oak, Dark Oak, Winchester Oak, Night Oak	
11'0" x 6'6"	3353 x 2000	1099	1348	1199	1448	1400	1649	1553	
7'0"	3353 x 2125	1141	1405	1246	1510	1454	1718	1614	
12'0" x 6'6"	3658 x 2000	1288	1559	1347	1618	1578	1849	1755	
7'0"	3658 x 2125	1337	1625	1400	1688	1640	1928	1824	
13'0" x 6'6"	3962 x 2000	1336	1630	1387	1681	1625	1919	1809	
7'0"	3962 x 2125	1386	1698	1438	1750	1686	1998	1877	
14'0" x 6'6"	4267 x 2000	1385	1701	1427	1743	1674	1990	1864	
7'0"	4267 x 2125	1439	1775	1483	1819	1740	2076	1938	
14'6" x 6'6"	4420 x 2000	1430	1758	1461	1789	1716	2044	1912	
7'0"	4420 x 2125	1487	1835	1520	1868	1786	2134	1990	
15'0" x 6'6"	4572 x 2000	1456	1795	1473	1812	1731	2070	1928	
7'0"	4572 x 2125	1513	1873	1534	1894	1802	2162	2008	
15'6" x 6'6"	4725 x 2000	1519	1869	1499	1849	1763	2113	1965	
7'0"	4725 x 2125	1578	1950	1558	1930	1832	2204	2043	
16'0" x 6'6"	4877 x 2000	1519	1880	1526	1887	1793	2154	1999	
7'0"	4877 x 2125	1578	1962	1585	1969	1864	2248	2078	

Intermediate sizes are available, please see your dealer for more details

All prices are in £ and are exclusive of VAT

15

# Hörmann Sectional Doors

## LPU 40 – double-skinned doors with steel sections – 42mm

Single doors with Z track tension springs giving low headroom as standard

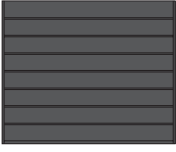
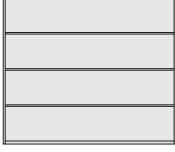
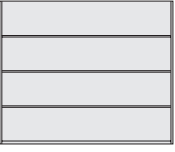
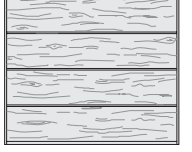

SINGLE DOORS		 <b>M-ribbed Titan Metallic CH 703</b>	 <b>L-ribbed Sandgrain</b>	 <b>L-ribbed Silkgrain / Micrograin</b>	 <b>L-ribbed Decograin</b>				
Door sizes BR						Anthracite grey Terra brown White aluminium		Rosewood, Golden Oak, Dark Oak, Winchester Oak, Night Oak	
Imperial	Metric					Outside White	Outside Colour	Outside White	Outside Colour
6'10" x 6'2"	2080 x 1875	1010	948	1093	1050	1195	1152		
6'6"	2080 x 2000	1057	973	1127	1078	1232	1181		
6'10"	2080 x 2080	1097	986	1147	1091	1252	1195		
7'0" x 6'6"	2134 x 2000	1057	973	1131	1078	1236	1181		
7'0"	2134 x 2125	1097	986	1154	1091	1259	1195		
7'6" x 6'6"	2286 x 2000	1057	973	1143	1078	1248	1181		
7'0"	2286 x 2125	1097	986	1166	1091	1271	1195		
7'4"	2286 x 2250	1151	1029	1220	1139	1330	1248		
7'9"	2286 x 2375	1200	1032	1233	1143	1344	1251		
8'2"	2286 x 2500	1248	1061	1273	1172	1384	1283		
8'0" x 6'6"	2438 x 2000	1120	1026	1207	1137	1318	1248		
7'0"	2438 x 2125	1168	1045	1237	1159	1351	1271		
7'4"	2438 x 2250	1205	1099	1302	1217	1420	1336		
7'9"	2438 x 2375	1259	1124	1339	1246	1461	1368		
8'2"	2438 x 2500	1318	1158	1384	1282	1508	1407		
8'6" x 6'6"	2591 x 2000	1120	1026	1218	1137	1329	1248		
7'0"	2591 x 2125	1168	1045	1249	1159	1363	1271		
9'0" x 6'6"	2740 x 2000	1230	1126	1329	1250	1453	1375		
7'0"	2740 x 2125	1278	1141	1357	1266	1482	1392		
9'6" x 6'6"	2896 x 2000	1297	1184	1399	1318	1533	1452		
7'0"	2896 x 2125	1348	1202	1430	1338	1566	1473		
10'0" x 6'6"	3048 x 2000	1297	1184	1410	1318	1544	1452		
7'0"	3048 x 2125	1348	1202	1442	1338	1578	1473		

For information on outside colour, see page 17

## Double doors with N track torsion springs (for low headroom see bottom of page 17)

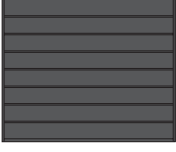
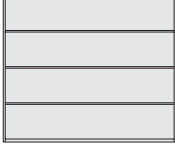
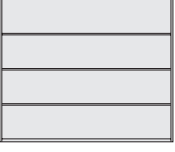
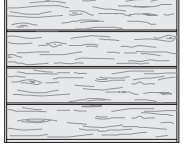
DOUBLE DOORS		 <b>M-ribbed Titan Metallic CH 703</b>	 <b>L-ribbed Sandgrain</b>	 <b>L-ribbed Silkgrain / Micrograin</b>	 <b>L-ribbed Decograin</b>				
Door sizes BR						Anthracite grey Terra brown White aluminium		Rosewood, Golden Oak, Dark Oak, Winchester Oak, Night Oak	
Imperial	Metric					Outside White	Outside Colour	Outside White	Outside Colour
11'0" x 6'6"	3353 x 2000	1553	1400	1649	1565	1814	1730		
7'0"	3353 x 2125	1614	1422	1686	1589	1853	1756		
12'0" x 6'6"	3658 x 2000	1755	1578	1849	1768	2039	1957		
7'0"	3658 x 2125	1824	1606	1894	1800	2088	1992		
13'0" x 6'6"	3962 x 2000	1809	1626	1920	1825	2119	2022		
7'0"	3962 x 2125	1877	1650	1962	1850	2162	2049		
14'0" x 6'6"	4267 x 2000	1864	1674	1990	1879	2195	2083		
7'0"	4267 x 2125	1938	1702	2038	1910	2246	2116		
14'6" x 6'6"	4420 x 2000	1912	1720	2048	1931	2259	2141		
7'0"	4420 x 2125	1990	1748	2096	1962	2310	2175		
15'0" x 6'6"	4572 x 2000	1928	1738	2077	1952	2291	2165		
7'0"	4572 x 2125	2008	1766	2126	1984	2344	2200		
15'6" x 6'6"	4725 x 2000	1965	1770	2120	1989	2339	2206		
7'0"	4725 x 2125	2043	1800	2172	2022	2394	2242		
16'0" x 6'6"	4877 x 2000	1999	1801	2162	2024	2385	2245		
7'0"	4877 x 2125	2078	1832	2216	2059	2443	2284		

Intermediate sizes are available, please see your dealer for more details

# Hörmann Sectional Doors

## LPU 40 – double-skinned doors with steel sections – 42mm

Single doors with Z track tension springs giving low headroom as standard

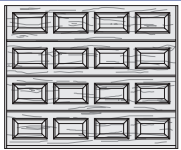
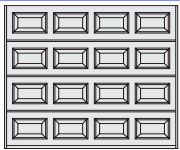

SINGLE DOORS		 <b>L-ribbed Titan Metallic CH 703</b>	 <b>S-panelled Decograin</b>	 <b>S-panelled Woodgrain</b>	No. of panels		No. of panels		
Door sizes BR					Rosewood, Golden Oak, Dark Oak, Winchester Oak, Night Oak	No. of panels	Outside White	Outside Colour	No. of panels
Imperial	Metric						Outside White	Outside Colour	
6'10" × 6'2"	2080 × 1875	1152	1234	4	944	1089	4		
	6'6"	2080 × 2000	1181	1260	4	989	1143	4	
	6'10"	2080 × 2080	1195		4	1001	1162	4	
7'0" × 6'6"	2134 × 2000	1181	1260	4	1024	1182	4		
	7'0"	2134 × 2125	1195	1274	4	1036	1204	4	
7'6" × 6'6"	2286 × 2000	1181	1260	4	1024	1194	4		
	7'0"	2286 × 2125	1195	1274	4	1036	1216	4	
	7'4"	2286 × 2250	1248	1391	4	1035	1226	4	
	7'9"	2286 × 2375	1251	1421	4	1104	1305	4	
8'0" × 6'6"	2438 × 2000	1248	1337	4	1080	1261	4		
	7'0"	2438 × 2125	1271	1355	4	1095	1287	4	
	7'4"	2438 × 2250	1336	1529	4	1091	1294	4	
	7'9"	2438 × 2375	1368	1549	4	1159	1374	4	
8'6" × 6'6"	2591 × 2000	1248	1337	4	1080	1272	4		
	7'0"	2591 × 2125	1271	1355	4	1095	1299	4	
	9'0" × 6'6"	2740 × 2000	1375	1466	4	1173	1376	4	
	7'0"	2740 × 2125	1392	1491	4	1191	1407	4	
9'6" × 6'6"	2896 × 2000	1452	1546	5	1231	1446	5		
	7'0"	2896 × 2125	1473	1574	5	1255	1483	5	
10'0" × 6'6"	3048 × 2000	1452	1546	5	1183	1409	5		
	7'0"	3048 × 2125	1473	1574	5	1206	1446	5	

For information on outside colour, see below

All coloured doors are special order only – 4 to 8 weeks delivery. Please note: the prices listed as Outside Colour are for the following RAL colours only: RAL 1015, 3003, 5011, 5014, 6005, 6009, 7016, 7030, 7035, 7040, 8001, 8003, 8028, 9006 and 9007. Special RAL colours are available, please ask your garage door specialist.

**Double doors with N track torsion springs (for low headroom see bottom of page)**

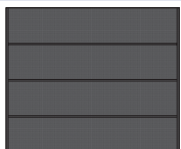
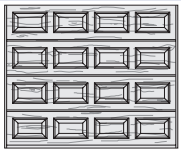
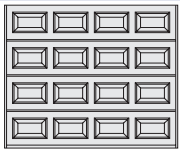
DOUBLE DOORS		 <b>L-ribbed Titan Metallic CH 703</b>	 <b>S-panelled Decograin</b>	 <b>S-panelled Woodgrain</b>	No. of panels		No. of panels		
Door sizes BR					Rosewood, Golden Oak, Dark Oak, Winchester Oak, Night Oak	No. of panels	Outside White	Outside Colour	No. of panels
Imperial	Metric						Outside White	Outside Colour	
11'0" × 6'6"	3353 × 2000	1730	1839	5	1409	1658	5		
	7'0"	3353 × 2125	1756	1869	5	1435	1699	5	
12'0" × 6'6"	3658 × 2000	1957	2079	6	1661	1932	6		
	7'0"	3658 × 2125	1992	2113	6	1688	1976	6	
13'0" × 6'6"	3962 × 2000	2022	2146	6	1727	2021	6		
	7'0"	3962 × 2125	2049	2177	6	1750	2062	6	
14'0" × 6'6"	4267 × 2000	2083	2212	7	1795	2111	7		
	7'0"	4267 × 2125	2116	2246	7	1823	2159	7	
14'6" × 6'6"	4420 × 2000	2141	2271	7	1860	2188	7		
	7'0"	4420 × 2125	2175	2308	7	1890	2238	7	
15'0" × 6'6"	4572 × 2000	2165	2298	7	1894	2233	7		
	7'0"	4572 × 2125	2200	2333	7	1925	2285	7	
15'6" × 6'6"	4725 × 2000	2206	2342	7	1986	2336	7		
	7'0"	4725 × 2125	2242	2378	7	2017	2389	7	
16'0" × 6'6"	4877 × 2000	2245	2386	7	1986	2347	7		
	7'0"	4877 × 2125	2284	2424	7	2017	2401	7	

**Low headroom**

Door with track application L, torsion spring at the back

**Price**

**105**

Intermediate sizes are available, please see your dealer for more details

All prices are in £ and are exclusive of VAT

17

# Hörmann Sectional Doors

## Optional extras and window designs



Colour surcharge		Price		
RAL to choose colours (please ask to see colour chart)	per m <sup>2</sup>	51		
Door leaf in special colours (please ask to see colour chart)	per m <sup>2</sup>	102		
Fittings				
Profile half cylinder 30 + 10mm, for garage door handle sets	each	36		
Handle sets				
Handle set, black plastic, prepared for profile cylinder	each	49		
Handle set, cast aluminium silver finish (F2), prepared for profile cylinder	each	123		
Handle set, cast aluminium RAL 9016, brown, brushed stainless steel, prepared for profile cylinder	each	139		
Handle set, polished stainless steel, prepared for profile cylinder	each	164		
Emergency release				
Emergency release for sectional doors <b>with or without</b> handle set (Please state at point of order)	each	39		
Special anchor set				
Set of 8 special anchors for between wall fitting	per set	40		
ThermoFrame set				
ThermoFrame set 1	Door height	up to 3000mm (length 3210 mm)	per set	207
	Door width	up to 3250mm (length 3250 mm)		
ThermoFrame set 2	Door height	up to 3000mm (length 3210 mm)	per set	244
	Door width	from 3250mm up to 6000mm (length 6000 mm)		
ThermoFrame set 3	For doors with track application H		per set	244

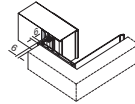
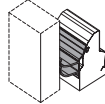
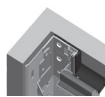

### Set consists of

- Lintel seal (1x) with 2 lip seals
- Plastic angle profiles (2x) black, 84 x 22.5 mm with lip seal (frame covering may be required to match the colours)

### Frame cover profiles matching the colour of the door – 55mm x 19.5mm and 90mm x 19.5mm: prices are per pair

Door heights	White RAL 9016						Colour						RAL to choose/CH 703				Decograin/Titan Metallic CH 703	
	Woodgrain		Sandgrain		Silkgrain		Woodgrain		Sandgrain		Silkgrain		Woodgrain		Silkgrain		55mm	90mm
	55mm	90mm	55mm	90mm	55mm	90mm	55mm	90mm	55mm	90mm	55mm	90mm	55mm	90mm	55mm	90mm		
1875mm	44	57	47	62	47	62	53	77	59	83	59	83	74	111	77	117	64	89
2000mm	46	60	50	66	50	66	56	82	62	88	62	88	78	118	82	124	68	94
2080mm	48	63	52	69	52	69	59	86	65	92	65	92	82	123	86	129	71	98
2125mm	49	64	54	71	54	71	60	88	66	94	66	94	83	126	88	132	73	100
2250mm	52	68	57	75	57	75	63	93	70	99	70	99	88	133	93	140	77	106
2375mm	55	72	60	79	60	79	67	98	74	105	74	105	93	141	98	148	81	112
2500mm	58	75	63	83	63	83	70	103	78	110	78	110	98	148	103	155	85	118

Silkgrain white/Titan Metallic CH 703 and Decograin colours are available ex-stock. **Please note colours and RAL to choose/CH 703 must be ordered with the door.**

Sandgrain is available in RAL 9016, 7016, 8028 and 9006

### Renovation fascias

Set: Renovation fascias to cover damaged brickwork edges consisting of: 3 angle sections, 69/40mm, each 3000mm long

Price	128	140	140	165	177	177	179	191	147
-------	-----	-----	-----	-----	-----	-----	-----	-----	-----

Set: Fascia frame -95- consisting of: 2 fascias, 95mm, 2800mm long, 1 fascia 95mm, 3200mm long, fixing material

Price	148	157	157	185	194	194	199	208	163
-------	-----	-----	-----	-----	-----	-----	-----	-----	-----

### Window designs for Sectional doors

LTE 40 with 3mm single pane in clear (FK) or crystal structure (KR), 3mm

LPU 40 with 16mm (for panelled) or 22mm (for ribbed) double pane in clear (DS) or crystal structure (DK)

	LPU 40	LTE 40
S0	76	70
S1	93	84
S2	93	84
S10	384	360
S20	480	450
S30	576	
S40	672	
S50	768	
S60	768	





Standard Colour Surcharges for the above windows. Please note: front window frame only is painted		Price
Standard colour or colour for Decograin	For glazing S0, S1 and S2	each 22
	For Sunrise glazing x No. of frames for width of door	each 27
RAL to choose	For glazing S0, S1 and S2	each 38
	For Sunrise glazing x No. of frames for width of door	each 50







# Aluminium Garage Side Doors

Double-leaf side doors with block frames made of aluminium profiles;  
door infill made of steel sectional door sections. Profile type 2



Size range										
	Exterior White	Exterior Color	Exterior White	Exterior Color	Exterior White	Exterior Color	Exterior White	Exterior Color	Exterior White	Exterior Color
Ordering sizes Overall frame dimensions (RAM)	<b>S-ribbed Woodgrain</b>		<b>M-ribbed Woodgrain</b>		<b>M-ribbed Sandgrain 1)</b>		<b>M-ribbed Silkgrain</b>		<b>M-ribbed Decograin 2)</b>	
Width × Height	Exterior White   Exterior Color		Exterior White   Exterior Color		Exterior White   Exterior Color		Exterior White   Exterior Color		Exterior White   Exterior Color	
Fitting in the opening (opening outwards)										
From 1355 × 1960										
Up to 1600 × 2100	<b>1886</b>	<b>2158</b>	<b>1886</b>	<b>2158</b>	<b>1958</b>	<b>2230</b>	<b>2018</b>	<b>2290</b>	<b>2206</b>	
Up to 1600 × 2250	<b>1893</b>	<b>2165</b>	<b>1893</b>	<b>2165</b>	<b>1964</b>	<b>2236</b>	<b>2025</b>	<b>2297</b>	<b>2213</b>	
Up to 1600 × 2558	<b>1900</b>	<b>2172</b>	<b>1900</b>	<b>2172</b>	<b>1971</b>	<b>2243</b>	<b>2033</b>	<b>2305</b>	<b>2221</b>	
Up to 1800 × 2100	<b>1906</b>	<b>2178</b>	<b>1906</b>	<b>2178</b>	<b>1979</b>	<b>2251</b>	<b>2040</b>	<b>2312</b>	<b>2230</b>	
Up to 1800 × 2250	<b>1912</b>	<b>2184</b>	<b>1912</b>	<b>2184</b>	<b>1986</b>	<b>2258</b>	<b>2047</b>	<b>2319</b>	<b>2237</b>	
Up to 1800 × 2558	<b>1919</b>	<b>2191</b>	<b>1919</b>	<b>2191</b>	<b>1993</b>	<b>2265</b>	<b>2055</b>	<b>2327</b>	<b>2245</b>	
Up to 2000 × 2100	<b>1927</b>	<b>2199</b>	<b>1927</b>	<b>2199</b>	<b>1999</b>	<b>2271</b>	<b>2062</b>	<b>2334</b>	<b>2252</b>	
Up to 2000 × 2250	<b>1933</b>	<b>2205</b>	<b>1933</b>	<b>2205</b>	<b>2006</b>	<b>2278</b>	<b>2069</b>	<b>2341</b>	<b>2260</b>	
Up to 2000 × 2558	<b>1940</b>	<b>2212</b>	<b>1940</b>	<b>2212</b>	<b>2013</b>	<b>2285</b>	<b>2077</b>	<b>2349</b>	<b>2268</b>	
Up to 2200 × 2100	<b>1946</b>	<b>2218</b>	<b>1946</b>	<b>2218</b>	<b>2020</b>	<b>2292</b>	<b>2084</b>	<b>2356</b>	<b>2276</b>	
Up to 2200 × 2250	<b>1953</b>	<b>2225</b>	<b>1953</b>	<b>2225</b>	<b>2028</b>	<b>2300</b>	<b>2091</b>	<b>2363</b>	<b>2285</b>	
Up to 2200 × 2558	<b>1960</b>	<b>2232</b>	<b>1960</b>	<b>2232</b>	<b>2035</b>	<b>2307</b>	<b>2098</b>	<b>2370</b>	<b>2293</b>	
Up to 2500 × 2100	<b>1966</b>	<b>2238</b>	<b>1966</b>	<b>2238</b>	<b>2041</b>	<b>2313</b>	<b>2106</b>	<b>2378</b>	<b>2300</b>	
Up to 2500 × 2250	<b>1973</b>	<b>2245</b>	<b>1973</b>	<b>2245</b>	<b>2048</b>	<b>2320</b>	<b>2113</b>	<b>2385</b>	<b>2308</b>	
Up to 2500 × 2558	<b>1980</b>	<b>2252</b>	<b>1980</b>	<b>2252</b>	<b>2055</b>	<b>2327</b>	<b>2118</b>	<b>2390</b>	<b>2316</b>	

Size range										
	Exterior White	Exterior Color	Exterior White	Exterior Color	Exterior White	Exterior Color	Exterior White	Exterior Color	Exterior White	Exterior Color
Ordering sizes Overall frame dimensions (RAM)	<b>L-ribbed Woodgrain</b>		<b>L-ribbed Sandgrain 1)</b>		<b>L-ribbed Silkgrain</b>		<b>L-ribbed Micrograin</b>		<b>L-ribbed Decograin 2)</b>	
Width × Height	Exterior White   Exterior Color		Exterior White   Exterior Color		Exterior White   Exterior Color		Exterior White   Exterior Color		Exterior White   Exterior Color	
Fitting in the opening (opening outwards)										
From 1355 × 1960										
Up to 1600 × 2100	<b>1950</b>	<b>2222</b>	<b>2024</b>	<b>2296</b>	<b>2087</b>	<b>2359</b>	<b>2087</b>	<b>2359</b>	<b>2281</b>	
Up to 1600 × 2250	<b>1957</b>	<b>2229</b>	<b>2032</b>	<b>2304</b>	<b>2094</b>	<b>2366</b>	<b>2094</b>	<b>2366</b>	<b>2289</b>	
Up to 1600 × 2558	<b>1963</b>	<b>2235</b>	<b>2039</b>	<b>2311</b>	<b>2101</b>	<b>2373</b>	<b>2101</b>	<b>2373</b>	<b>2297</b>	
Up to 1800 × 2100	<b>1970</b>	<b>2242</b>	<b>2047</b>	<b>2319</b>	<b>2108</b>	<b>2380</b>	<b>2108</b>	<b>2380</b>	<b>2305</b>	
Up to 1800 × 2250	<b>1979</b>	<b>2251</b>	<b>2054</b>	<b>2326</b>	<b>2115</b>	<b>2387</b>	<b>2115</b>	<b>2387</b>	<b>2313</b>	
Up to 1800 × 2558	<b>1985</b>	<b>2257</b>	<b>2061</b>	<b>2333</b>	<b>2123</b>	<b>2395</b>	<b>2123</b>	<b>2395</b>	<b>2321</b>	
Up to 2000 × 2100	<b>1992</b>	<b>2264</b>	<b>2068</b>	<b>2340</b>	<b>2131</b>	<b>2403</b>	<b>2131</b>	<b>2403</b>	<b>2330</b>	
Up to 2000 × 2250	<b>1998</b>	<b>2270</b>	<b>2075</b>	<b>2347</b>	<b>2138</b>	<b>2410</b>	<b>2138</b>	<b>2410</b>	<b>2338</b>	
Up to 2000 × 2558	<b>2005</b>	<b>2277</b>	<b>2083</b>	<b>2355</b>	<b>2145</b>	<b>2417</b>	<b>2145</b>	<b>2417</b>	<b>2346</b>	
Up to 2200 × 2100	<b>2013</b>	<b>2285</b>	<b>2090</b>	<b>2362</b>	<b>2152</b>	<b>2424</b>	<b>2152</b>	<b>2424</b>	<b>2354</b>	
Up to 2200 × 2250	<b>2019</b>	<b>2291</b>	<b>2098</b>	<b>2370</b>	<b>2159</b>	<b>2431</b>	<b>2159</b>	<b>2431</b>	<b>2362</b>	
Up to 2200 × 2558	<b>2027</b>	<b>2299</b>	<b>2105</b>	<b>2377</b>	<b>2166</b>	<b>2438</b>	<b>2166</b>	<b>2438</b>	<b>2371</b>	
Up to 2500 × 2100	<b>2034</b>	<b>2306</b>	<b>2112</b>	<b>2384</b>	<b>2174</b>	<b>2446</b>	<b>2174</b>	<b>2446</b>	<b>2379</b>	
Up to 2500 × 2250	<b>2040</b>	<b>2312</b>	<b>2119</b>	<b>2391</b>	<b>2182</b>	<b>2454</b>	<b>2182</b>	<b>2454</b>	<b>2388</b>	
Up to 2500 × 2558	<b>2047</b>	<b>2319</b>	<b>2124</b>	<b>2396</b>	<b>2191</b>	<b>2463</b>	<b>2191</b>	<b>2463</b>	<b>2395</b>	

1) Surface in **Sandgrain** only available in the colours RAL 7016 Anthracite grey, RAL 8028 Terra brown and RAL 9006 White aluminium. Other colours or RAL to choose are not possible!

2) **Decograin** surface with timber design film coating or decor film coating in Titan Metallic CH 703. Please state desired decor on order!

RAL to choose (in accordance with the RAL colour chart) or colour CH 703	£
Frame inside and outside, infill outside	Surcharge on white version per door <b>380</b>

# RollMatic Roller Garage Door

## Size range and prices

### Including operator



**Doors are only available in priced size range listed!** (Min. Production dimension 1000 x 1600mm) Note: Door size not over guide width

 <p>Exterior <b>White or Colour</b> (same price)</p>	Clear height (LH) = ordering size	3100					1521	1653	1697	1751	1795	2063	2137	2227	2272				
		3000					1521	1653	1697	1751	1795	2063	2137	2227	2272				
		2875					1521	1653	1697	1751	1795	2063	2137	2227	2272				
		2750					1499	1584	1635	1698	1763	2002	2088	2164	2240				
		2675	1379	1379	1430	1430	1499	1584	1635	1698	1763	2002	2088	2164	2240				
		2625	1379	1379	1430	1430	1499	1584	1635	1698	1763	2002	2088	2164	2240				
		2500	1379	1379	1430	1430	1450	1537	1589	1649	1697	1808	2010	2049	2132	2222	2271	2320	2367
		2375	1291	1291	1315	1315	1402	1511	1549	1583	1643	1747	1934	2011	2031	2146	2194	2244	2292
		2250	1291	1291	1315	1315	1402	1511	1549	1583	1643	1747	1934	2011	2031	2146	2194	2244	2292
		2125	1291	1291	1315	1315	1378	1466	1491	1533	1576	1661	1717	1944	1964	2086	2135	2184	2233
2000	1291	1291	1315	1315	1328	1403	1451	1501	1524	1602	1653	1863	1910	1997	2044	2094	2144		
1800	1291	1291	1315	1315	1328	1403	1451	1501	1524	1602	1653	1863	1910	1997	2044	2094	2144		
1600	1291	1291	1315	1315	1328	1403	1451	1501	1524	1602	1653	1863	1910	1997	2044	2094	2144		
		1000	1250	1500	1750	1900	2000	2250	2500	2750	3000	3250	3500	3750	4000	4250	4500	4750	5000
		Clear width (LB) = ordering size																	

**Manually operated version of the RollMatic roller garage door (not possible with external roller garage doors)** Price reduction **-154**

**External roller garage door** Surcharge **58**

**Additional fascia panel** (Reinforcement of the fascia panel for fitting in the opening) See page 22

**Doors are only available in the priced size range listed!** (Min. Production dimension 1000 x 1600mm) Note: Door size not over guide width

 <p>Exterior <b>Decopaint</b></p> <p>Golden Oak or Rosewood</p>	Clear height (LH) = ordering size	3100					1639	1785	1844	1912	1971	2254	2342	2447	2506				
		3000					1634	1781	1839	1907	1965	2247	2335	2440	2498				
		2875					1630	1776	1833	1901	1958	2239	2327	2431	2489				
		2750					1603	1701	1765	1841	1919	2171	2270	2359	2448				
		2675	1442	1456	1519	1527	1601	1698	1761	1838	1915	2166	2265	2353	2442				
		2625	1442	1454	1517	1525	1599	1696	1759	1835	1912	2163	2262	2350	2438				
		2500	1439	1450	1513	1520	1545	1644	1708	1779	1839	1962	2176	2226	2321	2423	2484	2544	2603
		2375	1348	1359	1394	1401	1492	1612	1662	1707	1778	1893	2092	2179	2210	2337	2396	2457	2516
		2250	1345	1355	1390	1397	1487	1607	1656	1700	1771	1886	2083	2171	2201	2327	2386	2446	2505
		2125	1342	1352	1386	1392	1459	1557	1592	1644	1697	1792	1858	2095	2125	2257	2316	2375	2434
2000	1339	1348	1381	1387	1404	1488	1546	1605	1637	1725	1785	2005	2061	2158	2214	2273	2333		
1800	1334	1343	1375	1380	1397	1480	1536	1595	1627	1713	1772	1991	2047	2142	2197	2256	2314		
1600	1334	1343	1375	1380	1397	1480	1536	1595	1627	1713	1772	1991	2047	2142	2197	2256	2314		
		1000	1250	1500	1750	1900	2000	2250	2500	2750	3000	3250	3500	3750	4000	4250	4500	4750	5000
		Clear width (LB) = ordering size																	

**Manually operated version of the RollMatic roller garage door (not possible with external roller garage doors)** Price reduction **-154**

**External roller garage door** Surcharge **58**

**Additional fascia panel** (Reinforcement of the fascia panel for fitting in the opening) See page 22



# Optional Extras

## For RollMatic roller garage door including operator



<b>Fitting compensation set</b>	<b>£</b>
To accommodate for unevenness on the building structure when fitting behind/in front of the opening	<b>Included in the door price</b>

### Chamfered bottom profile (not available with external roller garage doors)

RollMatic roller garage door with chamfered bottom profile (not available in the surfaces Golden Oak and Rosewood)	In black	Per m	<b>179</b>
	in door colour	Per m	<b>179</b>

### Additional fascia panel for fitting in the opening

In door colour	Per m	<b>47</b>
----------------	-------	-----------

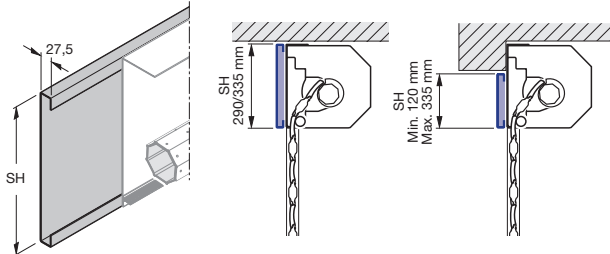

Reinforcement of the fascia panel

► State height (SH) and width!

For fitting in the opening, indicate the height (SH) 290 mm or 335 mm and total width = ordering size (clear width) +200 mm

**Note:**

State on door order, subsequent fitting is not possible.

### Optional extras for internal roller garage doors only

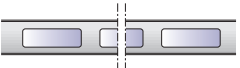
	<b>Glazing element</b> With clear synthetic pane, window cut-out 112 x 33 mm, black glazing frame on exterior, transparent on interior (maximum of 10 sections per door, number of glazing elements depending on the door width) For side doors this is not possible in the bottom section and the lock area	Per m	<b>20</b>
---	--	-------	-----------

	<b>Ventilation grille</b> Black plastic Ventilation cross section: approx. 13 cm <sup>2</sup> /grille (maximum of 10 sections per door, number of ventilation grilles dependent on the door width) For side doors this is not possible in the bottom section and the lock area	Per m	<b>20</b>
---	---	-------	-----------

<b>Without barrel casing</b>	(only possible from a clear height (LH) of 2500mm)	Price reduction	Per m	<b>-13</b>
------------------------------	--	-----------------	-------	------------

### Accessories for RollMatic operators

	Article no.		<b>£</b>
Motor connection line, 10 m	436523		<b>29</b>
Acoustic anti-lift kit	436524	Each	<b>48</b>
Emergency battery HNA 18	437727	Each	<b>124</b>

### Emergency release

			<b>£</b>
Exterior emergency release for internal roller garage door		436526	Each <b>77</b>
Exterior emergency release for external roller garage door	Exterior emergency release	436526	Each <b>77</b>
	Accessory bag for double secured release	437728	Each <b>6</b>
	Bowden cable, length 1 m, for double secured release SE	437986	Each <b>10</b>

**Note:** All 3 articles are required for the external roller garage door!

### Matching side door and accessories



Style 996

Ordering sizes Nominal size	Style 996	Style 996	Style 996
Width x Height	White or Colour	Decopaint Golden Oak or Rosewood	Decograin Golden Oak or Rosewood
<b>Size Range</b>			
From 675 x 1750			
Up to 1000 x 2000	<b>689</b>	<b>730</b>	<b>878</b>
Up to 1250 x 2375	<b>738</b>	<b>799</b>	<b>965</b>

### Lever handle sets for side doors

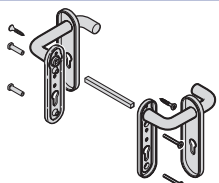

Standard: black plastic, prepared for profile cylinder	Each	1324002	<b>40</b>
Silver finish (F2) cast aluminium, prepared for profile cylinder	Each	1386100	<b>137</b>
Cast aluminium RAL 9016 (white), prepared for profile cylinder	Each	1386150	<b>171</b>
Cast aluminium RAL 8028 (brown), prepared for profile cylinder	Each	1386330	<b>171</b>
Brushed stainless steel, prepared for profile cylinder	Each	1386351	<b>206</b>
Polished stainless steel, prepared for profile cylinder	Each	1386350	<b>206</b>

### Lever/knob handle set for side doors

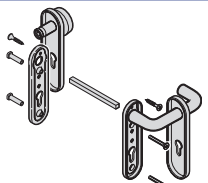

Standard: black plastic, prepared for profile cylinder	Each	1380000	<b>84</b>
Silver finish (F2) cast aluminium, prepared for profile cylinder	Each	1380100	<b>168</b>
Cast aluminium RAL 9016 (white), prepared for profile cylinder	Each	1380150	<b>202</b>
Cast aluminium RAL 8028 (brown), prepared for profile cylinder	Each	1380330	<b>202</b>
Brushed stainless steel, prepared for profile cylinder	Each	1380351	<b>251</b>
Polished stainless steel, prepared for profile cylinder	Each	1380350	<b>251</b>

# Garage Door Operators

## Operator Accessories



### Garage door operators





Boom Length	SupraMatic E	SupraMatic P	SupraMatic HT	ProMatic	ProMatic Akku
<b>K</b>	471	503	For prices and specification see the 01-15 A Price List	374	634
<b>M</b>	488	519		391	651
<b>L</b>	578	610		481	741

Hand transmitters with BiSecur technology are backwards compatible, i.e. they can also be used with series 1 and 2 operators (868 MHz). Hand transmitter 868 MHz BiSecur, incl. battery (Range of radio signal depends on local conditions)

- Possible
- Only in combination with a BiSecur radio receiver
- Only in conjunction with the BiSecur radio receiver ESE, status query possible
- Not possible

### Garage door operators

SupraMatic E / P	SupraMatic HT	ProMatic	ProMatic Akku	RollMatic
------------------	---------------	----------	---------------	-----------

Accessory	Description					
<b>HS</b> 1-button hand transmitter  black <b>HS 1 BS</b> Art. no. 436750 £ 52	<b>High gloss plastic surface with chromed zinc die-cast caps</b> <ul style="list-style-type: none"> <li>• Impulse</li> <li>• Protection category: for dry rooms only</li> <li>• Temperature range: -20 °C to +60 °C</li> <li>• Battery: 1.5 V LR03 / AAA</li> <li>• Dimensions: 38 x 95 x 16 mm</li> </ul>	●	○	●	●	●
<b>HS</b> 4-button hand transmitter  black <b>HS 4 BS</b> Art. no. 436751 £ 54	<b>High gloss plastic surface with chromed zinc die-cast caps</b> <ul style="list-style-type: none"> <li>• Impulse</li> <li>• Protection category: for dry rooms only</li> <li>• Temperature range: -20 °C to +60 °C</li> <li>• Battery: 1.5 V LR03 / AAA</li> <li>• Dimensions: 38 x 95 x 16 mm</li> </ul>	●	○	●	●	●
<b>HS</b> 5-button hand transmitter   black                      White <b>HS 5 BS                      HS 5 BS</b> Art. no. 436752                      436753 £ 66                                      66	<b>High gloss plastic surface with chromed zinc die-cast caps</b> <ul style="list-style-type: none"> <li>• Impulse</li> <li>• Status query</li> <li>• Protection category: for dry rooms only</li> <li>• Temperature range: -20 °C to +60 °C</li> <li>• Battery: 1.5 V LR03 / AAA</li> <li>• Dimensions: 38 x 95 x 16 mm</li> </ul>	●	□	●	-	-
<b>HS</b> 5-button hand transmitter  black <b>HS 5 BS</b> Art. no. 436946 £ 66	<b>Textured plastic surface with chrome-plated zinc diecast caps</b> <ul style="list-style-type: none"> <li>• Impulse</li> <li>• Status query</li> <li>• Protection category: for dry rooms only</li> <li>• Temperature range: -20 °C to +60 °C</li> <li>• Battery: 1.5 V LR03 / AAA</li> <li>• Dimensions: 38 x 95 x 16 mm</li> </ul>	●	□	●	-	-



# Garage Door Operators

## Operator Accessories



Hand transmitters with BiSecur technology are backwards compatible, i.e. they can also be used with series 1 and 2 operators (868 MHz). Hand transmitter 868 MHz BiSecur, incl. battery (Range of radio signal depends on local conditions)

- Possible
- Only in combination with a BiSecur radio receiver
- Only in conjunction with the BiSecur radio receiver ESE, status query possible
- Not possible

Accessory		Description	Garage door operators				
			SupraMatic E / P	SupraMatic HT	ProMatic	ProMatic Akku	RollMatic
<b>HSS</b> 4-button security hand transmitter  Red <b>HSS 4 BS</b> Art. no. 436756 £ 92		<b>High gloss plastic surface in red with chrome-plated zinc diecast caps</b> <ul style="list-style-type: none"> <li>• Impulse</li> <li>• Additional function: Copy protection for hand transmitter coding (e.g. property management)</li> <li>• Protection category: for dry rooms only</li> <li>• Temperature range: -20 °C to +60 °C</li> <li>• Battery: 1.5 V LR03 / AAA</li> <li>• Dimensions: 38 × 95 × 16 mm</li> </ul> <b>Note:</b> Not downward compatible	●	○	●	○	○
<b>Accessories</b> For hand transmitters (HS and HSS)  Black White <b>Hand transmitter station</b> Art. no. 436691 436692 £ 7 7		<ul style="list-style-type: none"> <li>• For HS 1 BS, HS 4 BS, HS 5 BS, HSS 4 BS</li> </ul>					
<b>Accessories</b> For hand transmitters (HS and HSS)  <b>Hand transmitter holder</b> Transparent, incl. visor clip Art. no. 436698 £ 6		<ul style="list-style-type: none"> <li>• For HS 1 BS, HS 4 BS, HS 5 BS, HSS 4 BS</li> <li>• For wall fitting or for fitting to the visor clip</li> <li>• Without fitting material</li> </ul>					
<b>HSE</b> 1-button hand transmitter  Black <b>HSE 1 BS</b> Art. no. 436937 £ 52		<b>High gloss plastic surface with chromed zinc die-cast caps</b> <ul style="list-style-type: none"> <li>• Impulse</li> <li>• Incl. key ring for fixing to the key chain</li> <li>• Protection category: for dry rooms only</li> <li>• Temperature range: 0 °C to +60 °C</li> <li>• Battery: Lithium round cell 3 V / type CR 2032</li> <li>• Dimensions: 28 × 70 × 14 mm</li> </ul>	●	○	●	●	●

# Garage Door Operators

## Operator Accessories







Hand transmitters with BiSecur technology are backwards compatible, i.e. they can also be used with series 1 and 2 operators (868 MHz). Hand transmitter 868 MHz BiSecur, incl. battery (Range of radio signal depends on local conditions)

- Possible
- Only in combination with a BiSecur radio receiver
- Only in conjunction with the BiSecur radio receiver ESE, status query possible
- Not possible

### Garage door operators

SupraMatic E / P	SupraMatic HT	ProMatic	ProMatic Akku	RollMatic
------------------	---------------	----------	---------------	-----------

Accessory	Description	SupraMatic E / P	SupraMatic HT	ProMatic	ProMatic Akku	RollMatic
<b>HSE</b> 2-button hand transmitter  Black <b>HSE 2 BS</b> White <b>HSE 2 BS</b> Art. no. 436754      436755 £ <b>52</b> <b>52</b>	<b>High gloss plastic surface with chromed zinc die-cast caps</b> <ul style="list-style-type: none"> <li>• Impulse</li> <li>• Incl. key ring for fixing to the key chain</li> <li>• Protection category: for dry rooms only</li> <li>• Temperature range: 0 °C to +60 °C</li> <li>• Battery: Lithium round cell 3 V / type CR 2032</li> <li>• Dimensions: 28 × 70 × 14 mm</li> </ul>					
<b>HSE</b> 2-button hand transmitter HSE 2 BS Housing colour      Art. no.      £		●	○	●	●	●
Purple	436869	<b>73</b>				
Orange	436870	<b>73</b>				
Yellow	436871	<b>73</b>				
Red	436872	<b>73</b>				
Green	436873	<b>73</b>				
Carbon	436863	<b>73</b>				
Silver	436864	<b>73</b>				
Timber*, light	436867	<b>73</b>				
Rootwood*, light	436868	<b>73</b>				
Timber*, dark	436865	<b>73</b>				
Rootwood*, dark	436866	<b>73</b>				
	* Timber or rootwood look					
<b>HSE</b> 2-button hand transmitter  Black <b>HSE 2 BS</b> Art. no. 437953 £ <b>52</b>	<b>Textured plastic surface with chrome-plated zinc diecast caps</b> <ul style="list-style-type: none"> <li>• Impulse</li> <li>• Incl. key ring for fixing to the key chain</li> <li>• Protection category: for dry rooms only</li> <li>• Temperature range: 0 °C to +60 °C</li> <li>• Battery: Lithium round cell 3 V / type CR 2032</li> <li>• Dimensions: 28 × 70 × 14 mm</li> </ul>	●	○	●	●	●
<b>HSE</b> 2-button hand transmitter  Black <b>HSE 2 BS</b> Art. no. 436942 £ <b>47</b>	<b>Textured plastic surface with plastic caps</b> <ul style="list-style-type: none"> <li>• Impulse</li> <li>• Incl. key ring for fixing to the key chain</li> <li>• Protection category: for dry rooms only</li> <li>• Temperature range: 0 °C to +60 °C</li> <li>• Battery: Lithium round cell 3 V / type CR 2032</li> <li>• Dimensions: 28 × 70 × 14 mm</li> </ul>	●	○	●	●	●
<b>Accessories</b> For hand transmitter (HSE) 	<ul style="list-style-type: none"> <li>• For HSE 1 BS and HSE 2 BS</li> <li>• For wall fitting or for fitting to the visor clip</li> <li>• Without fitting material</li> </ul>					
<b>Hand transmitter holder</b> Transparent incl. visor clip Art. no. 437006 £ <b>6</b>						

# Garage Door Operators

## Operator Accessories



Hand transmitters with BiSecur technology are backwards compatible, i.e. they can also be used with series 1 and 2 operators (868 MHz). Hand transmitter 868 MHz BiSecur, incl. battery (Range of radio signal depends on local conditions)

- Possible
- Only in combination with a BiSecur radio receiver
- Only in conjunction with the BiSecur radio receiver ESE, status query possible
- Not possible

### Garage door operators

SupraMatic E / P	SupraMatic HT	ProMatic	ProMatic Akku	RollMatic
------------------	---------------	----------	---------------	-----------

Accessory	Description	SupraMatic E / P	SupraMatic HT	ProMatic	ProMatic Akku	RollMatic
<b>HSP</b> 4-button hand transmitter  Black <b>HSP 4 BS</b> Art. no. 436776 £ 60	<ul style="list-style-type: none"> <li>• Impulse</li> <li>• With sliding switch as a button lock-out</li> <li>• Incl. key ring</li> <li>• Protection category: for dry rooms only</li> <li>• Temperature range: -20 °C to +60 °C</li> <li>• Battery: Lithium round cell 3 V / type CR 2025</li> <li>• Dimensions (D × H): Ø 48 × 13 mm</li> </ul>	●	○	●	●	●
<b>HSD</b> 2-button hand transmitter   Aluminium Chrome <b>HSD 2-A BS</b> <b>HSD 2-C BS</b> Art. no. 436774    436775 £ 67    67	<ul style="list-style-type: none"> <li>• Impulse</li> <li>• High-quality metal housing</li> <li>• As a key ring</li> <li>• Protection category: for dry rooms only</li> <li>• Temperature range: -20 °C to +60 °C</li> <li>• Battery: Lithium round cell 3 V / type CR 2025</li> <li>• Dimensions (W × H × D): 32 × 66 × 13 mm</li> </ul>	●	○	●	●	●
<b>HSZ</b> 1-button hand transmitter    2-button hand transmitter   Black    Black <b>HSZ 1 BS</b> <b>HSZ 2 BS</b> Art. no. 436779    436782 £ 50    50	<ul style="list-style-type: none"> <li>• Impulse</li> <li>• For insertion in a vehicle cigarette lighter</li> <li>• Protection category: for dry rooms only</li> <li>• Temperature range: -20 °C to +60 °C</li> <li>• Battery: Lithium 3 V / type CR 2</li> <li>• Dimensions (D × H): Ø 29 × 39 mm</li> </ul>	●	○	●	●	●

### Batteries

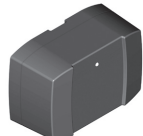
<b>HNA</b> Emergency battery  <b>HNA 18-3</b> Art. no. 43726 £ 141	<ul style="list-style-type: none"> <li>• Emergency power supply to bypass power failures up to 18 hours and max. 5 door cycles (depending on temperatures, situation of charge etc.)</li> <li>• To be fixed on operator or garage ceiling</li> <li>• Protection category: For dry rooms only</li> <li>• Weight: approx. 2.3 kg</li> <li>• Operating voltage: 24 V DC / 2.3 Ah</li> <li>• Dimensions (W × H × D): 150 × 70 × 90 mm</li> </ul> Suitable for series 2 ProMatic and SupraMatic operators.	●	●	●	-	●
<b>HNA</b> Emergency battery  <b>HNA Outdoor</b> Art. no. 436522 £ 148	<ul style="list-style-type: none"> <li>• Emergency power supply to bridge power outages</li> <li>• Universal fixing for wall and floor fitting</li> <li>• Double LED function display</li> <li>• Protection category: IP 65</li> <li>• Weight: 3 kg</li> <li>• Dimensions: 213 × 143 × 96</li> <li>• Battery voltage: 24 V DC / 2.3 Ah</li> </ul> For RotaMatic / P / PL from Autumn 2010 and for LineaMatic / P / H from year of manufacture 10 / 2009.	-	-	-	-	-

# Garage Door Operators

## Operator Accessories

**NEW**  
Available  
from autumn 2015







Hand transmitters with BiSecur technology are backwards compatible, i.e. they can also be used with series 1 and 2 operators (868 MHz). Hand transmitter 868 MHz BiSecur, incl. battery (Range of radio signal depends on local conditions)

- Possible
- Only in combination with a BiSecur radio receiver
- Only in conjunction with the BiSecur radio receiver ESE, status query possible
- Not possible

Garage door operators				
SupraMatic E/P	SupraMatic HT	ProMatic	ProMatic Akku	RollMatic

### Radio internal push button / internal receiver

<p><b>FIT</b> 1-button radio internal push button</p> <p><b>// NEW</b> Available from autumn 2015</p>  <p>Art. no. <b>FIT 1 BS</b> 439740</p> <p>£ <b>89</b></p>	<ul style="list-style-type: none"> <li>● Impulse</li> <li>● Protection category: for dry rooms only</li> <li>● Temperature range: -20 °C to +60 °C</li> <li>● Battery: 2 x 1.5 V LRO3 / AAA</li> <li>● Colour: Pure white RAL 9010</li> <li>● Dimensions (W x H x D): 80 x 80 x 15 mm</li> </ul>	●	○	●	●	●
<p><b>FIT</b> 4-button radio internal push button</p> <p><b>// NEW</b> Available from autumn 2015</p>  <p>Art. no. <b>FIT 4 BS</b> 439741</p> <p>£ <b>89</b></p>	<ul style="list-style-type: none"> <li>● Impulse</li> <li>● Protection category: for dry rooms only</li> <li>● Temperature range: -20 °C to +60 °C</li> <li>● Battery: 2 x 1.5 V LRO3 / AAA</li> <li>● Colour: Pure white RAL 9010</li> <li>● Dimensions (W x H x D): 80 x 80 x 15 mm</li> </ul>	●	○	●	●	●
<p><b>FIT</b> 5-button radio internal push button</p> <p><b>// NEW</b> Available from autumn 2015</p>  <p>Art. no. <b>FIT 5 BS</b> 439742</p> <p>£ <b>103</b></p>	<ul style="list-style-type: none"> <li>● Impulse</li> <li>● Status query</li> <li>● Protection category: for dry rooms only</li> <li>● Temperature range: -20 °C to +60 °C</li> <li>● Battery: 2 x 1.5 V LRO3 / AAA</li> <li>● Colour: Pure white RAL 9010</li> <li>● Dimensions (W x H x D): 80 x 80 x 15 mm</li> </ul>	●	□	●	-	-
<p><b>FES</b> Radio receiver electric socket</p> <p><b>// NEW</b> Available from autumn 2015</p>  <p>Art. no. <b>FES 1</b> 439762</p> <p>£ <b>95</b></p>	<ul style="list-style-type: none"> <li>● To switch the light and further consumers on / off</li> <li>● Functions: impulse, on and off, status feedback</li> <li>● Protection category: for dry rooms only</li> <li>● Temperature range: -20 °C to +60 °C</li> <li>● Operating voltage: 100 - 240 V AC</li> <li>● Electric socket switching capacity:               <ul style="list-style-type: none"> <li>- 2500 W / 10 A resistivity</li> <li>- 500 W inductive load</li> </ul> </li> <li>● Colour: Pure white RAL 9010</li> <li>● Dimensions (W x H x D): 80 x 80 x 57 mm (without pins)</li> </ul>					
<p><b>FES</b> Radio receiver electric socket</p> <p><b>// NEW</b> Available from autumn 2015</p>  <p>Art. no. <b>FES 1-1</b> 439763</p> <p>£ <b>95</b></p>	<ul style="list-style-type: none"> <li>● For the control (impulse) of operators of other makes as well as switching on / off lights and other consumers</li> <li>● Functions:               <ul style="list-style-type: none"> <li>- Impulse, on and off, with status feedback (channel 1)</li> <li>- Impulse for operators of other makes, without operator status feedback (channel 2)</li> </ul> </li> <li>● Protection category: for dry rooms only</li> <li>● Temperature range: -20 °C to +60 °C</li> <li>● Operating voltage: 100 - 240 V AC</li> <li>● Electric socket switching capacity:               <ul style="list-style-type: none"> <li>- 2500 W / 10 A resistivity</li> <li>- 500 W inductive load</li> </ul> </li> <li>● Impulse output switching capacity: 40 V / max. 100 mA</li> <li>● With connecting lead 1 x 2 m, 2-wire</li> <li>● Colour: Pure white RAL 9010</li> <li>● Dimensions (W x H x D): 80 x 80 x 57 mm (without pins)</li> </ul>					

# Garage Door Operators

## Operator Accessories



Hand transmitters with BiSecur technology are backwards compatible, i.e. they can also be used with series 1 and 2 operators (868 MHz). Hand transmitter 868 MHz BiSecur, incl. battery  
(Range of radio signal depends on local conditions)

- Possible
- Only in combination with a BiSecur radio receiver
- Only in conjunction with the BiSecur radio receiver ESE, status query possible
- Not possible

### Garage door operators

SupraMatic E / P	SupraMatic HT	ProMatic	ProMatic Akku	RollMatic
------------------	---------------	----------	---------------	-----------

### Radio internal push button 868 MHz BiSecur, incl. battery (Range of radio signal depends on local conditions)

**FIT** Radio internal push button



- With 2 impulse push buttons for control of 2 operators by radio signal
- One additional button for On/Off function of connected command units
- Connection option for max. 2 control elements (volt-free contact) e.g. key switch
- Battery: 1.5 V LR03 / AAA
- Temperature range: 0°C to +60°C
- Protection category: IP 20, for dry rooms only
- Dimensions (W x H x D): 30 x 110 x 35 mm

**FIT 2 BS**

Art. no. 436757

£ 54

● ○ ● ● ●

**IT 3b** Internal push buttons



- With illuminated impulse button, additional buttons for light on/off and operator on/off
- With 7 m connecting lead, 2-wire
- Protection category: IP 20, for dry rooms only
- Dimensions (W x H x D): 80 x 110 x 30 mm

**IT 3b**

Art. no. 436204

£ 35

● ● - - -

**FCT 3 BS** Radio code switch



- Impulse, for control of up to 3 door operators
- Transmission of up to 3 radio codes, 868 MHz
- Power supply: Battery 4 x 1.5 V LR03 / AAA
- **Illuminated keypad**, clip frame
- Protection category: IP 54
- Temperature range: -20°C to +60°C
- Housing: Plastic
- Dimensions (W x H x D): 80 x 135 x 40 mm

**FCT 3 BS**

Art. no. 436758

£ 89

● ○ ● ● ●

**FCT 10 BS** Radio code switch



- Impulse, for control of up to 10 door operators
- Transmission of up to 10 radio codes, 868 MHz
- Power supply: Battery 4 x 1.5 V LR03 / AAA
- **Illuminated keypad**, sliding cover with metal embellishment
- Protection category: IP 54
- Temperature range: -20°C to +60°C
- Housing: Plastic
- Dimensions (W x H x D): 80 x 135 x 40 mm

**FCT 10 BS**

Art. no. 436759

£ 146

● ○ ● ● ●

### Radio finger-scan 868 MHz BiSecur (range of radio signal depends on local conditions!)

**FFL** Radio finger-scan



- Impulse, to control 2 operators using a fingerprint
- Up to 12 fingerprints can be taught in, cannot be individually deleted
- Setting / programming via 3 buttons
- Housing: Plastic, sliding cover with metal embellishment
- Display via 3 LEDs
- Battery: 4 x 1.5 V LR03 / AAA
- Protection category: IP 54
- Temperature range: -20°C to +60°C
- Dimensions (W x H x D): 80 x 130 x 45 mm

**FFL 12 BS**

Art. no. 436788

£ 208

Only for use with Hörmann BiSecur 868 MHz receivers.

● ○ ● ● ●

# Garage Door Operators

## Operator Accessories



The new hand transmitters, radio internal push buttons and code buttons with BiSecur technology are downwards compatible, i.e. they can also be used with series 1 and 2 operators (868 MHz).

- Possible
- Only in combination with a BiSecur radio receiver
- Only in conjunction with the BiSecur radio receiver ESE, status query possible
- Not available

### Garage door operators

SupraMatic E / P	SupraMatic HT	ProMatic	ProMatic Akku	RollMatic
------------------	---------------	----------	---------------	-----------

### BiSecur LAN / WLAN Gateway



#### BiSecur Gateway

Art. no. 4511708  
£ 233

- Central interface for controlling operators by smartphone or tablet
- Protection category: IP 20
- Power supply: 100–240 V AC
- Secondary voltage: 5 V DC / 1.0 A
- Housing: White plastic (RAL 9003)
- Temperature range: –20 °C to +60 °C
- Dimensions (W × H × D):  
135 × 30 × 32 mm  
154 × 30 × 32 mm (with fastening eyelets)
- Scope of delivery:  
Network cable CAT 5 E, 1 m  
Power supply unit 100–240 V AC  
Cable from USB-A to DC

●	□	●	-	-
---	---	---	---	---

#### Note:

An automatic door system may only be controlled without visual contact to the door if a photocell has been installed on the door in addition to the standard power limit.

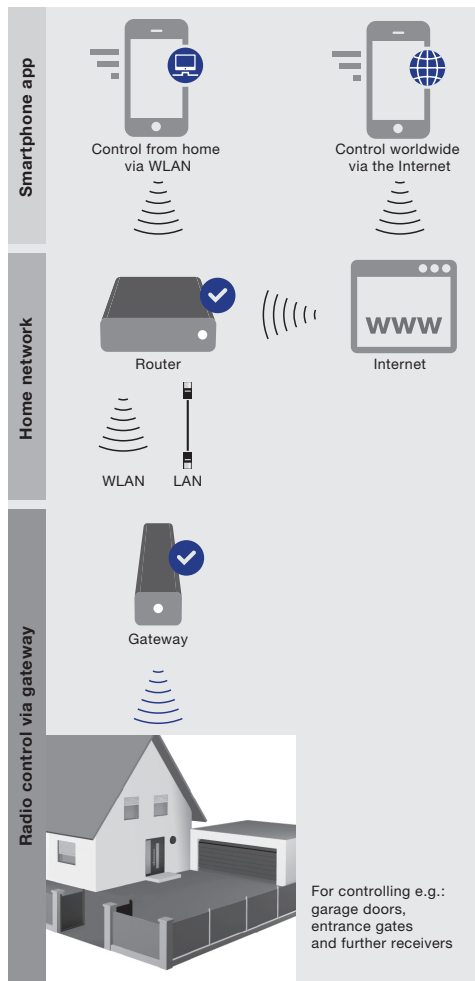

### BiSecur Gateway

The central interface for operators and radio receivers enables operation by an administrator and 9 other users. In total, up to 16 functions can be carried out by each user. The control unit can be connected to the router of your home network either through a network cable (LAN) or wirelessly (WLAN).

The connection to the router in the home network is established via network cable (LAN version) or wirelessly (WLAN version). The strength of the WLAN signal can be tested via an LED on the gateway, in order to find the most suitable location for operation.

### System prerequisites:

#### Android devices

- From software version 2.3
- Min. 256 MB RAM

#### iOS devices

- From software version iOS 6
- From iPod touch 5th generation
- From iPhone 4S
- From iPad 2
- From iPad mini

#### Home network

- Broadband Internet access
- Internet browser
  - Firefox from version 14
  - Chrome from version 22
  - Safari from version 4
  - Internet Explorer from version 10
  - Other current web browsers that support JavaScript and CSS 3
- WLAN router
  - WLAN standard IEEE 802.11 b/g/n
  - WPA-PSK or WPA2-PSK encryption
- Available LAN socket on router
- Power supply (110–240 V AC / 50 / 60 Hz)
- Smartphone or tablet with access to the App Store<sup>SM</sup> or to Google<sup>TM</sup> play
- Location with remote connection to the device to be operated

### Hörmann Portal BiSecur Home

The smartphone and the gateway must be registered via the Hörmann Portal for worldwide control via the Internet. A one-time registration is done via a certified Hörmann Internet site and ensures the highest data security.



# Warranty

Hörmann products are manufactured to the highest quality standards and leave our factory only after rigorous quality testing. However, if you should have grounds for complaint, this section tells you what our door warranty offers, and how to go about making your claim.

In the unlikely event of a warranty claim becoming necessary, please contact the dealer or distributor who originally supplied your garage door. Your dealer should then supply details of the claim, together with a copy of the warranty card provided with the door and proof of purchase to the Product Services Department at Hörmann (UK) Ltd. To enable your claim under warranty to be processed as quickly as possible, you should provide the following details:

1. Your name, address and telephone number
2. Original invoice with date of purchase
3. Product description/door type and product number
4. Description of defect

An assessment of the claim will then be made. This may require Hörmann to inspect the product in-situ. In the event that there is no legitimate warranty claim under the terms specified herein, you may be liable for the costs of the inspection visit. We strongly recommend that you take note of the care and usage instructions displayed on the stickers on the back of your garage door, and on the page opposite, and that you follow these instructions throughout.

## Hörmann installers

Hörmann (UK) Ltd has a nationwide network of recommended installers who will be able to offer you a regular maintenance service on your garage door. Please call us on 01530 513050 for details of your nearest dealer.

## Hörmann (UK) Ltd Garage Door Warranty

<b>Warranty Period</b>	The purchaser is granted a warranty covering the safe and reliable function of the Hörmann garage door for a period of 10 years from the date of purchase. A 5 year warranty applies to springs, wire cables, track rollers, hinges and guide rollers. The warranty period for replacement parts is 6 months or to the end of the current warranty period, whichever is longer. In the case of foil-coated timber-effect, a warranty of 5 years is granted, for timber and GRP doors a warranty of 2 years is granted on the door panels alone under the terms and conditions specified herein. The door mechanism and steel frame (if applicable) is covered by the 10 year warranty period.
<b>Requirements</b>	Warranty claims are only applicable in the country where the garage door was purchased. The product must have been purchased through our authorised distribution channels. The warranty only covers damage to the contract object. The fully completed warranty card together with the receipt of purchase correspondingly dated substantiates your right to claim under the warranty.
<b>Performance</b>	During the warranty period we undertake to rectify any and all defects to the Hörmann product which can be proved to be attributed to a material or manufacturing fault. We pledge at our discretion either to exchange the defective merchandise for faultless merchandise, repair it or allow a reduction in price. We do not accept costs for dismantling and installation nor for carriage. Replaced parts become our property. The warranty does not cover damage caused through: <ul style="list-style-type: none"> <li>• normal wear and tear</li> <li>• improper installation</li> <li>• negligent care and maintenance</li> <li>• improper initial and subsequent operation</li> <li>• negligent or wanton destruction</li> <li>• external influences such as fire, water, salts, alkaline solutions, acids, abnormal environmental influences</li> <li>• mechanical damage through improper transport and fitting</li> <li>• priming and other surface protection treatments</li> <li>• incorrect or too late applied surface protection treatments</li> <li>• repair by non-qualified persons</li> <li>• using non-Hörmann parts without the approval of the manufacturer</li> <li>• removal of the product number or making it unidentifiable</li> </ul>

## Electric Operator Warranty

A separate 5 year warranty is granted on our electric operators. This includes operator mechanics, motor and motor control systems. A 2 year warranty is granted on radio equipment, accessories and system controls. There is no warranty on consumables (e.g. fuses, batteries, bulbs etc.). For further details please contact us on 01530 513030 or through our website on [www.hormann.co.uk](http://www.hormann.co.uk)

## User Information/Care

### Finish – Steel Doors

The coating process applied to the door and chassis is environmentally friendly. Minor scratches or marks are not covered under the conditions of our warranty and should be repaired immediately to prevent corrosion and deterioration of the panel. Corrosive substances such as acids, alkalines, and salts, etc. should be cleaned from the door immediately; failure to do so will result in deterioration of the finish, which will not be covered under our warranty. Should deterioration of the finish start to occur you will need to repaint your door immediately. Prepare the surface lightly with wet and dry. Then treat with solvent based 2 pack epoxy wash primer and a normal commercial paint (cellulose paint must not be used). Hörmann steel doors are a finished product. They do not require re-painting on site. They are however not immune to damage, which can occur at any stage of the handling of the product from factory to site.

### Finish – Timber Doors

Timber panels are coated with a neutralising base-stain. Doors must be stored upright, under cover, with wrapping intact, until wrapping is removed. As soon as the door is unwrapped, one coat of a good quality basecoat primer must be applied to both sides of the door. Immediately after installation, your timber doors require a further two coats of a good quality exterior wood finish on both sides. Initial application and periodic treatment should be carried out strictly in accordance with the woodstain manufacturer's instructions. Failure to follow these instructions will result in early deterioration of the timber panel.

### Finish – GRP Doors

GRP door panels should periodically be washed down using water. This should be done more frequently if fitted near the sea. Bird droppings will bleach the finish on GRP and should be removed using water as soon as possible. GRP doors should not be painted over.

### Paint Finish – Steel Doors

Minor surface damage can easily be repaired using touch up sprays or sticks without invalidating warranties.

# Extracts from DHF consumer advice



The following document was designed by the Association of Garage Door Specialists, updated by the DHF and endorsed by all major UK garage door manufacturers, as a guide for purchasers of domestic garage doors.

## Visual appearance of Garage Doors

A new garage door can be a significant investment that will transform the appearance of your home. This information is a guide to the quality you can expect.

## The Quality Check

The quality check should be carried out in natural daylight, not direct sunlight. Stand at a distance of 3 metres from the door to view the overall appearance. The door is acceptable if, taking into account the facts below, none of the following are readily visible on the face of the door:

- Marks or distortion associated with the manufacturing process
- Minor indentations, marks or scuffs on the surface
- Paint or stain blemishes

## The Facts

### Steel Doors

**Panel Distortion** The rolling or pressing of steel panels during manufacture will cause distortion in the steel and while every effort is made to keep this to a minimum, inevitably some visible distortion will remain. The application of high gloss paints will make this slight distortion more apparent, especially under certain lighting conditions, such as car headlamps, or bright sunshine.

**Paint Finish** Primed doors – the primer coating is applied as a base coat only and as such requires additional finishing with a good quality exterior paint. Any marks or scratches on the primer coat should be rubbed down and repainted as part of this finishing process.

**Timber Doors** Finished doors – the factory application of the paint finish is an automated process and this may result in minor blemishes or slight inconsistencies in the paint, particularly in the area of panel joints.

### Timber

Timber is a natural product and there will be variations in pattern, colour, shading and grains. No two doors will be the same, because wood naturally expands and contracts according to environmental conditions, joints will open and close and some minor curvature may occur.

It is vital that timber doors are fully finished as per the manufacturers instructions before exposure to the elements.

### GRP and Composite Plastic Doors

**Mould Marks** GRP doors are individually handcrafted in a mould and are then hand finished. Some minor marks and blemishes will inevitably remain after this process.

**Translucency** When viewed from the inside, it is often possible to see variations in the translucency of the door, particularly around and between areas of relief. Such variations do not detract from the overall strength or build quality of the door.

### All Doors

**Colour Match** Pairs of doors should be ordered together to obtain the best colour match, bearing in mind the limitations of the materials used in the construction. Timber garage doors cannot be ordered as matching sets.

**Size Variation** As the size of a door changes in height and/or width, the panel frequency and profile can change, therefore doors of the same style but of different sizes can be significantly different in appearance.

**Clearances** All doors require operating clearances, i.e. the gap between the door panel and the frame opening, these are inbuilt during manufacture and should not be reduced by means of infills, or draughtproofing.

**Deflection** When in the open position, all doors will display a level of vertical deflection or “sag” across the width of the panel. Individual manufacturers' specifications should be consulted for exact tolerances.

### Power Operated Garage Doors

It is against the law to install a power operated garage door in the UK without complying with the Machinery Directive.

To comply with the Machinery Directive both the door and the operator used in the installation must have a Declaration of Incorporation from the manufacturer.

On completion of the installation the installer must provide a Declaration of Conformity and apply a CE mark giving details of the installation to the door/operator combination, which is now classed as a machine.

The installer must issue to the customer a Declaration of Conformity on completion of the installation.

The installer must hold copies of both the Declaration of Incorporation and the Declaration of Conformity on a technical file for inspection by the relevant authorities.

If any of the above requirements are not fulfilled the installation is illegal.

Please ensure for your own safety and peace of mind that whoever installs your electric operator is both willing and able to fulfil these requirements; if they are not – do not use them!

Members of the DHF Garage Door Installer Group can and will install your Hörmann operator safely and legally.

Since the company's policy is one of continuous improvement of its products, we reserve the right to make any alterations in design, manufacture or price. All business is governed by the company's Standard Conditions and this document does not form any part of any contract with the company and statements contained in it should not be construed as representations or warranties.